

sunlite[®]

Fluorescent | Incandescent | Halogen | HID | Specialty
Catalog 2019

ABOUT US

Sunshine Lighting was founded in 1980 by Morty Kohn as a one man operation. It evolved into a multinational enterprise, growing at a rapid pace to become one of the leading lighting manufacturers in the United States. Sunshine Lighting takes great pride in maintaining the personal relationship with each customer.

In 1996 Sunshine Lighting began developing and manufacturing the Sunlite® brand, producing many lighting technologies, including a vast selection of LED, Compact Fluorescent, Incandescent, HID, Halogen, Decorative, Miniature, Specialty, Stage and Studio lamps as well as a large collection of electrical supplies and Light Fixtures. The Sunlite® brand has gained a reputation of quality and affordability and keeps up with the latest technologies to provide the most advanced products in the lighting industry.

In today's fast paced world, we understand that availability is vital. With our 100,000+ square feet of warehouse space we stock more than 13,000 different products so that we are able to provide immediate service to all our customers. We also carry all major brands including Osram-Sylvania, General Electric (GE), Philips, Ushio, Universal and many others.

Through customer interaction and feedback, we work tirelessly to introduce new and innovative products to the marketplace as well as constantly improving our existing line of items to meet the high expectations our customers have come to rely on us for.

Our dedicated team of technical and product specialists ensures that our products are designed with safety and the environment in mind. Many of our products carry the Underwriters Laboratories and/or Energy Star certifications. Sunlite® is also partnered with the U.S. Department of Energy (DOE) Lighting Facts program, the Design Lights Consortium (DLC), and the American Lighting Association (ALA) among others.

For product inquiries or to place an order, please contact us at:

TOLL FREE PHONE: **800.605.BULB**

VISIT: **www.sunlite.com**

For general information: **info@sunlite.com**

Sales department: **sales@sunlite.com**

To request a catalog: **catalog@sunlite.com**

New York

744 Clinton Street
Brooklyn, NY 11231
t: 718.768.7000
f: 718.768.0970

Florida

3698 1/2 NW 16th Street Bay C
Lauderhill, FL 33311
t: 954.316.6130
f: 954.316.6019

sunlite®



TABLE OF CONTENTS



COMPACT FLUORESCENT

Spiral	8 - 11
Chandelier/Globe/Jar	11
Tubular/A Type	12
Reflector	12 - 13



CFL PLUG-IN

PL U-shaped Twin Tube	18 - 19
PLT 4-Pin Triple Tube	19 - 20
FUL 4-pin Single U-Shaped Twin Tube	20
FDL 2-Pin Quad Tube	20
FML 4-pin Quad Tube	21
FT 4-Pin Twin Tube	21



LINEAR FLUORESCENT

T5 Straight Tube / Circline	26 - 28
2D Lamp	28
T8 / T12 Tube	28 - 29
T9 Circline / T12 Tube / Black Light Tube	30
T2 Subminiature FM Lamp / Appliance Tube	31
TubeGuard Covers / End Caps	32 - 33



INCANDESCENT

A TYPE	38-39
Antique Style / High Wattage	40
Chandelier	40 - 43
Globe	43 - 47
S11 / S14 / Night Light	45 - 47
Reflector	47 - 48
S6 / PRE / Elevator	49
Tubular	49 - 51



HALOGEN

JDD Double Envelope T10	56
T4 / Double Ended T3	56 - 58
Reflector	58 - 63
A Type	63



HIGH INTENSITY DISCHARGE

A Type / High Pressure Sodium	66 - 67
Metal Halide / Mercury Vapor	



SPECIALTY

Xelogen / Xenon / Minis	70 - 71
Stage & Studio	72 - 73



sunlite



COMPACT FLUORSCENT



COMPACT FLUORESCENT LAMPS

HOW IT WORKS

CFLs are rapidly replacing the incandescent light bulb in nearly every application possible. They both require electricity to light up, they have a glass cover, they have a screw-in base, but that's where their similarities end. Instead of a glowing filament, CFLs contain argon and mercury vapor housed, most commonly, within a spiral-shaped tube. CFLs are actually descendants of the long tube-shaped linear fluorescent lamps still found in commercial fixtures. CFLs, however, are "self-ballasted"- they have their ballast built into the base. This ballast produces an electric current that passes through the vaporous mixture and excites the gas molecules causing it to produce ultraviolet light. The ultraviolet light stimulates the phosphorous coating painted on the inside of the tube. As the phosphor absorbs the energy, it converts the UV light to visible light.

TRI-PHOSPHOR COATING

This mixture painted inside the glass tube converts UV light into visible light.

COMPACT FLUORESCENT TUBE

Unlike linear fluorescent tubes, these thin tubes are shaped to reduce their size and increase their light output.

ELECTRONIC BALLAST

The ballast enables the lamp to light up immediately with no flickering or noise.

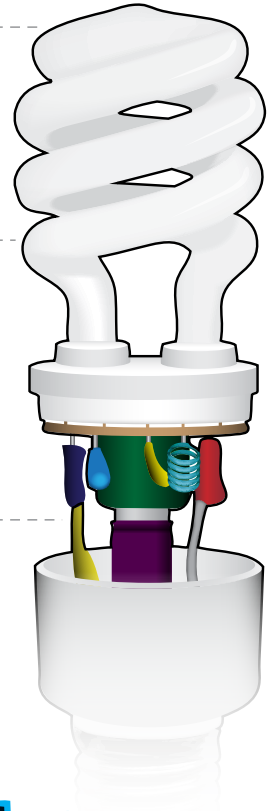

IT'S ALL ABOUT COLOR

The way CFLs render colors has been the number one reason for years that made CFLs so unappealing. Fluorescent light of the past is still associated with giving off an unflattering green glow. Although this was true in older fluorescent models, seen mostly in institutional settings using cool color temperatures, technology and an insight for consumer needs has allowed an astronomical advance in the type of fluorescent lighting available today. The spectrum of colors and quality of light has broadened and improved to make the CFL a standard household lighting choice. Educating your customers about lamp color and color rendering will help dispel any remaining misgivings and allow them to make choices to fit their lighting needs without compromising aesthetics or the energy saving benefits.

SEE HOW DIFFERENTLY THE SAME APPLE LOOKS LIT WITH BULBS OF DIFFERENT COLOR TEMPERATURES...

COLOR TEMPERATURE



WARM WHITE
2700-3000K

COOL WHITE
4100K

SUPER WHITE
5000K

DAYLIGHT
6500K

The color temperature, measured in Kelvins, refers to a lamp's emitted color. A Warm White color temperature of 2700 to 3000 Kelvin (K), makes reds, oranges and yellows more prominent and is most similar to the light emitted by an incandescent lamp. Light sources with a color temperature in the 4100K range, also known as Cool White, bring out cooler tones. Daylight colored lamps, which measure at 6500K, give off a bluish light which resembles actual day light.

Why Use CFL?

The following are some reasons why making the switch to CFLs is a no-brainer. Of course, none of these benefits would matter if CFLs didn't perform well, give off excellent light, or be used in so many applications. CFLs, however, are quite versatile and truly can replace most incandescent bulbs. Some compact fluorescent light bulbs can even be used with CFL-ready dimmer switches and in three-way lamps. Combine that with the many benefits that incandescent bulbs don't offer, and you've got yourself one superior bulb.



SAVE ENERGY

CFLs use significantly less energy -- 75 percent less energy than incandescent light bulbs. That means CFLs require less wattage to produce an equivalent amount of light. For example, you could use a 20-watt CFL and enjoy the same amount of light as a 75-watt incandescent. According to the EPA, if every home in America would switch just one bulb, enough energy would be saved in one year to light more than 3 million homes.



SAVE THE ENVIRONMENT

Using less energy will, in turn, save the user money in energy costs. Replacing a standard 60-watt bulb with a 13-watt CFL can save a single household \$30 in energy costs over the life of the bulb. This calculation is based on the national average of \$0.11/kWh multiplied by the life of the bulb and its wattage. Although CFLs are more expensive than incandescent lamps, most CFLs can last up to 10 times longer -- the cost of one CFL will save money in energy cost and keep you from having to replace the incandescent lamp every 800 to 1,500 hours.



SAVE MONEY

A good deal of electricity coming from coal powered plants gets directed to the lamps and light fixtures inside the home. When less energy is consumed due to the use of CFL lamps, less electricity is being pulled from the power grid reducing the amount of coal being burned and in turn reducing emissions of greenhouse gases. Using CFLs instead of incandescent bulbs can, over only one year, remove as much greenhouse gas pollution as taking 2 million cars off the road.

the DOWNSIDE D_{Hg}OMNISI_DD_{Hg}DE

CFLs are not worry-free, however. They contain an element toxic to living things. If there is an ugly truth about CFL bulbs, it's the mercury they hold within their glass covers. Mercury is a persistent and highly toxic chemical. Most commonly, humans are exposed to the poison by eating fish contaminated with methyl mercury; however, it's also possible to inhale elemental mercury vapor, like the kind used in compact fluorescent light bulbs.

So why is it used in CFLs instead of some other element? Mercury vapor is required to convert electrical energy to the UV light needed to radiate the phosphor found inside the bulb so that it can be converted to visible light. No other element has proved as efficient in this process. Only a small amount of mercury, an average of 5 milligrams (compare that to the 500-600 milligrams used in manual thermometers), is required for CFLs to function properly and the amounts of mercury used has significantly decreased over time. Also, the mercury found inside isn't harmful as long as the bulb remains intact. For this reason, extra caution must be taken when cleaning up a broken CFL.

the
good
thing
is...

Interestingly enough, with all the hype surrounding the mercury content, using CFLs actually helps eliminate mercury from the environment.

Coal actually contains mercury and when coal is burned to produce electricity, the toxin is released into the environment. Approximately 13.6 milligrams of mercury are released from the coal used to power one 60-watt incandescent bulb, but only 3.3 milligrams to power an equivalent CFL bulb.

IF A BULB BREAKS, THE U.S. ENVIRONMENTAL PROTECTION AGENCY (EPA) RECOMMENDS THESE FOUR EASY STEPS:

1
2
3
4

First, turn off your central heating or cooling system so fumes aren't moved from one room to another. Then, open up the windows and let the room ventilate for 15 minutes.

Next, it's time to clean up the broken bulb. Put on gloves to make sure you don't touch any of the mercury powder. Use a piece of cardboard to scoop up large pieces of glass. Switch to sticky tape to pick up small fragments and shards. Don't use your vacuum cleaner, and make sure all broken pieces, tape, and cardboard are placed in a plastic bag.

Finally, wipe the area with a damp paper towel and place the used towel in the plastic bag, as well.

Seal the bag and immediately throw it away.



SUPER MINI SPIRAL

Base	Watts	Item	Description	Lumens	Volts	Hours	Color	Kelvin	MOL	Pkg	Features	
Medium (E26)	5	00703-SU	SMS5/27K	300	120	10,000	Warm White	2700K	2.91"	24		
	7	00634-SU	SMS7/27K	430	120	10,000	Warm White	2700K	2.85"	24		
	9		00638-SU	SMS9/27K	500	120	10,000	Warm White	2700K	3.60"	24	
			00606-SU	SMS9/27K/APK	500	120	10,000	Warm White	2700K	3.19"	24	
			00639-SU	SMS9/41K	500	120	10,000	Cool White	4100K	3.60"	24	
		00640-SU	SMS9/65K	500	120	10,000	Daylight	6500K	3.62"	24		
11	00643-SU	SMS11/65K	600	120	10,000	Daylight	6500K	3.83"	24			
Candelabra (E12)	13	00818-SU	SMS13/27K/E12	850	120	12,000	Warm White	2700K	4.00"	24		
Medium (E26)		00817-SU	SMS13/27K	900	120	12,000	Warm White	2700K	4.56"	24		
		00805-SU	SMS13/27K	900	120	10,000	Warm White	2700K	3.97"	24		
13		00607-SU	SMS13/27K/CD4	900	120	10,000	Warm White	2700K	4.10"	6		
		00612-SU	SMS13/27K/CD1	900	120	10,000	Warm White	2700K	4.18"	24		
		00699-SU	SMS13/30K	900	120	10,000	Warm White	3000K	4.16"	24		
		00707-SU	SMS13/41K	900	120	10,000	Cool White	4100K	3.78"	24		
		00806-SU	SMS13/50K	900	120	10,000	Super White	5000K	4.02"	24		
		00807-SU	SMS13/65K	900	120	10,000	Daylight	6500K	3.95"	24		
		00608-SU	SMS13/65K/CD4	900	120	10,000	Daylight	6500K	4.10"	6		
		00815-SU	SMS13/65K/CD1	900	120	10,000	Daylight	6500K	4.02"	24		
		00811-SU	SMS18/27K	1250	120	10,000	Warm White	2700K		24		
		00812-SU	SMS18/27K/CD4	1200	120	10,000	Warm White	2700K	4.52"	6		
18		00819-SU	SMS18/65K/CD4	1200	120	10,000	Daylight	6500K		6		
		00649-SU	SMS18/65K	1200	120	10,000	Daylight	6500K	4.37"	24		
		00727-SU	SMS20/65K	1235	120	12,000	Daylight	6500K	4.22"	24		
20		00832-SU	SMS23/27K	1600	120	12,000	Warm White	2700K	4.56"	24		
		00831-SU	SMS23/ES/27K/CD4	1600	120	10,000	Warm White	2700K	4.62"	6		
		00688-SU	SMS23/41K	1600	120	10,000	Cool White	4100K	4.70"	24		
		00621-SU	SMS23/50K	1600	120	10,000	Super White	5000K	4.53"	24		
		00697-SU	SMS23/65K	1600	120	10,000	Daylight	6500K	4.74"	24		
		00826-SU	SMS23/65K/CD1	1520	120	10,000	Daylight	6500K	4.66"	24		
		00835-SU	SMS23/65K/CD4	1500	120	10,000	Daylight	6500K	4.46"	6		
23		00672-SU	SMS26/27K	1600	120	10,000	Warm White	2700K	5.27"	24		
		00632-SU	SMS26/41K	1600	120	10,000	Cool White	4100K	2.45"	24		
		00714-SU	SMS26/50K	1500	120	10,000	Super White	5000K	4.84"	24		
		00633-SU	SMS26/65K	1800	120	10,000	Daylight	6500K	4.75"	24		
26												



GU24 SPIRAL

Base	Watts	Item	Description	Lumens	Volts	Hours	Color	Kelvin	MOL	Pkg	Features
GU24	13	00655-SU	SL13/GU24/27K	900	120	10,000	Warm White	2700K	3.90"	24	
		00787-SU	SL13/GU24/41K	900	120	10,000	Cool White	4100K	3.90"	24	
		00789-SU	SL13/GU24/50K	900	120	10,000	Super White	5000K	3.50"	24	
	18	00660-SU	SL18/GU24/27K	1250	120	10,000	Warm White	2700K	4.50"	24	
		00792-SU	SL18/GU24/41K	1200	120	10,000	Cool White	4100K	4.20"	24	
	20	00836-SU	SL20/GU24/50K	1235	120	12,000	Super White	5000K	3.74"	24	
	23	00665-SU	SL23/GU24/27K	1600	120	10,000	Warm White	2700K	4.06"	24	
		00798-SU	SL23/GU24/41K	1600	120	10,000	Cool White	4100K	4.06"	24	
		00793-SU	SL23/GU24/50K	1550	120	10,000	Super White	5000K	4.70"	24	
	27	05494-SU	SL27/GU24/27K	1700	120	10,000	Warm White	2700K	4.90"	24	



3 WAY SPIRAL

Base	Watts	Item	Description	Lumens	Volts	Hours	Color	Kelvin	MOL	Pkg	Features
Medium (E26)	13-20-25	05379-SU	SL25/3W/E/27K/CD1	900 /1200 /1600	120	8,000	Warm White	2700K	6.07"	12	



COLORED MINI SPIRAL

Base	Watts	Item	Description	Lumens	Volts	Hours	Color	Kelvin	MOL	Pkg	Features
Medium (E26)	20	05439-SU	SL20/BLB		120	8,000	Black Light Blue	N/A	5.61"	12	■
		05501-SU	SM13/B		120	8,000	Blue	N/A	4.44"	24	■
	13	05502-SU	SM13/G		120	8,000	Green	N/A	4.45"	24	■
		05505-SU	SM13/R		120	10,000	Red	N/A	4.50"	24	■
		05503-SU	SM13/Y		120	8,000	Yellow	N/A	4.50"	24	■



COLORED SPIRAL

Base	Watts	Item	Description	Lumens	Volts	Hours	Color	Kelvin	MOL	Pkg	Features
Medium (E26)	24	05511-SU	SL24/B		120	8,000	Blue	N/A	5.02"	24	■
		05512-SU	SL24/G		120	8,000	Green	N/A	5.00"	24	■
		05513-SU	SL24/R		120	8,000	Red	N/A	5.00"	24	■
		05514-SU	SL24/Y		120	8,000	Yellow	N/A	5.00"	24	■

■ = Black Light Blue ■ = Carded (# signifies pieces per card)

PHONE / 718.768.7000

FAX / 718.768.0970

WWW.SUNLITE.COM



DIMMABLE SPIRAL

Base	Watts	Item	Description	Lumens	Volts	Hours	Color	Kelvin	MOL	Pkg	Features
Medium (E26)	18	05468-SU	SL18/27K/D	1200	120	10,000	Warm White	2700K	5.28"	12	■
	20	05467-SU	SL20/27K/D	1350	120	10,000	Warm White	2700K	5.46"	12	■
	23	05479-SU	SL23/27K/D	1600	120	10,000	Warm White	2700K	5.73"	12	■



PURION AIR PURIFICATION SPIRAL

Base	Watts	Item	Description	Lumens	Volts	Hours	Color	Kelvin	MOL	Pkg	Features
Medium (E26)	15	05568-SU	AP15/30K	900	120	10,000	Warm White	3000K	5.49"	12	
		05569-SU	AP15/65K	900	120	10,000	Daylight	6500K	5.32"	12	
	23	05571-SU	AP23/30K	1500	120	10,000	Warm White	3000K	5.90"	12	
		05572-SU	AP23/65K	1500	120	10,000	Daylight	6500K	5.78"	12	

HIGH WATTAGE SPIRAL

Base	Watts	Item	Description	Lumens	Volts	Hours	Color	Kelvin	MOL	Pkg	Features
Medium (E26)	32	05545-SU	SL32/27K	2250	120	8,000	Warm White	2700K	5.35"	24	
		05546-SU	SL32/65K	2030	120	8,000	Daylight	6500K	5.64"	24	
	42	05596-SU	SL42/27K	2800	120	12,000	Warm White	2700K	6.90"	24	
		05597-SU	SL42/65K	2400	120	12,000	Daylight	6500K	6.89"	24	
	65	05515-SU	SL65/41K/MED	3600	120	10,000	Cool White	4100K	9.55"	6	
		05577-SU	SL65/65K/MED	3400	120	8,000	Daylight	6500K	9.60"	6	
Mogul (E26)	65	05518-SU	SL65/27K/MOG	4300	120	10,000	Warm White	2700K	9.88"	6	
	65	05578-SU	SL65/65K/MOG	3400	120	8,000	Daylight	6500K	9.85"	6	
Medium (E26)	85	05528-SU	SL85/27K/MED	5700	120	10,000	Warm White	2700K	9.89"	6	
		05529-SU	SL85/30K/MED/277V	4200	277	8,000	Warm White	3000K	10.52"	6	▲
		05581-SU	SL85/30K/MED	4200	120	8,000	Warm White	3000K	10.56"	6	
		05523-SU	SL85/50K/MED	4200	120	8,000	Super White	5000K	10.65"	6	
		05580-SU	SL85/65K/MED	4200	120	8,000	Daylight	6500K	10.70"	6	
		05535-SU	SL85/65K/MED/277V	4200	277	8,000	Daylight	6500K	10.70"	6	▲
Mogul (E39)	85	05598-SU	SL85/65K/MOG	4200	120	8,000	Daylight	6500K	11.10"	6	
Medium (E26)	105	05588-SU	SL105/30K/MED	5800	120	8,000	Warm White	3000K	10.97"	6	
		05537-SU	SL105/30K/277V	5000	277	8,000	Warm White	3000K	10.96"	6	▲
		05555-SU	SL105/41K/MED	7000	120	10,000	Cool White	4100K	10.68"	6	
		05527-SU	SL105/50K/MED	5000	120	8,000	Super White	5000K	11.46"	6	
		05593-SU	SL105/65K/MED	5000	120	8,000	Daylight	6500K	11.50"	6	
Mogul Screw (E39)	105	05544-SU	SL105/30K/MOG/277V	5000	277	8,000	Warm White	3000K	11.30"	6	▲
		05563-SU	SL105/41K/MOG/277V	5000	277	8,000	Cool White	4100K	11.90"	6	▲
		05557-SU	SL105/41K/MOG	5000	120	8,000	Cool White	4100K	11.86"	6	
		05559-SU	SL105/65K/MOG	5000	120	8,000	Daylight	6500K	12.09"	6	



SUPER HIGH WATTAGE SPIRAL

Base	Watts	Item	Description	Lumens	Volts	Hours	Color	Kelvin	MOL	Pkg	Features
Mogul (E39)	150	05582-SU	SL150/27K/MOG	7900	120	8,000	Warm White	2700K	13.38"	6	
		05601-SU	SL150/50K/MOG	7660	120	8,000	Super White	5000K	13.27"	6	
	200	05587-SU	SL200/27K/MOG	9500	120	8,000	Warm White	2700K	14.19"	6	
		05602-SU	SL200/50K/MOG	9200	120	8,000	Super White	5000K	14.19"	6	



CHANDELIER

Base	Watts	Item	Description	Lumens	Volts	Hours	Color	Kelvin	MOL	Pkg	Features
Medium (E26)	7	05296-SU	SLM7/27K	340	120	10,000	Warm White	2700K	4.73"	12	
	14	65751-SU	SLM14TW/27K	620	120	8,000	Warm White	2700K	5.60"	12	
		65750-SU	SLM14TW/30K	620	120	8,000	Warm White	3000K	5.66"	12	
		65760-SU	SLM14TW/65K	620	120	8,000	Daylight	6500K	5.66"	12	



GLOBE

Base	Watts	Item	Description	Lumens	Volts	Hours	Color	Kelvin	MOL	Pkg	Features
Medium (E26)	9	05345-SU	SLG9/G25/30K	360	120	8,000	Warm White	3000K	5.15"	12	
	5	05341-SU	SLG5/G19/30K	200	120	8,000	Warm White	3000K	4.35"	12	
	20	05358-SU	SLG20/G30/50K	900	120	8,000	Super White	5000K	5.86"	12	
	25	05321-SU	SLG25/G30/50K	1125	120	8,000	Super White	5000K	6.12"	12	

COLORED GLOBE

Base	Watts	Item	Description	Lumens	Volts	Hours	Color	Kelvin	MOL	Pkg	Features
Medium (E26)	9	05660-SU	SLG9/G		120	8,000	Green		4.63"	24	■
		05680-SU	SLG9/P		120	8,000	Pink		4.60"	24	■
		05670-SU	SLG9/R		120	8,000	Red		4.60"	24	■
		05690-SU	SLG9/Y		120	8,000	Yellow		4.63"	24	■

JAR

Base	Watts	Item	Description	Lumens	Volts	Hours	Color	Kelvin	MOL	Pkg	Features
Medium (E26)	14	05324-SU	SLJ14/27K	800	120	8,000	Warm White	2700K	5.25"	12	





TUBULAR

Base	Watts	Item	Description	Lumens	Volts	Hours	Color	Kelvin	MOL	Pkg	Features
Medium (E26)	7	05295-SU	SL7T10/27K	340	120	10,000	Warm White	2700K	4.78"	12	

A TYPE



Base	Watts	Item	Description	Lumens	Volts	Hours	Color	Kelvin	MOL	Pkg	Features
Medium (E26)	11	05300-SU	SLB11/27K/CD1	450	120	8,000	Warm White	2700K	6.14"	12	
	14	05309-SU	SLB14/65K	750	120	10,000	Daylight	6500K	4.84"	24	

GU10 MINI REFLECTOR



Base	Watts	Item	Description	Lumens	Volts	Hours	Color	Kelvin	MOL	Pkg	Features
GU10	9	05438-SU	SM9GU10/30K	280	120	8,000	Warm White	3000K	2.90"	24	

R20 REFLECTOR



Base	Watts	Item	Description	Lumens	Volts	Hours	Color	Kelvin	MOL	Pkg	Features
Medium (E26)	14	65765-SU	SL14R20/27K	500	120	10,000	Warm White	2700K	4.88"	12	

R40 REFLECTOR COLORED



Base	Watts	Item	Description	Lumens	Volts	Hours	Color	Kelvin	MOL	Pkg	Features
Medium (E26)	25	05610-SU	SL25R40/G		120	8,000	Green		7.00"	12	■
		05630-SU	SL25R40/P		120	8,000	Pink		7.05"	12	■
		05620-SU	SL25R40/R		120	8,000	Red		7.02"	12	■



COLORED PAR38 REFLECTOR

Base	Watts	Item	Description	Lumens	Volts	Hours	Color	Kelvin	MOL	Pkg	Features
Medium (E26)	23	05362-SU	SL23PAR38/B		120	8,000	Blue		5.40"	12	■
		05367-SU	SL23PAR38/G		120	8,000	Green		5.40"	12	■
		05372-SU	SL23PAR38/R		120	8,000	Red		5.22"	12	■

PHONE / 718.768.7000

FAX / 718.768.0970

WWW.SUNLITE.COM

sunlite

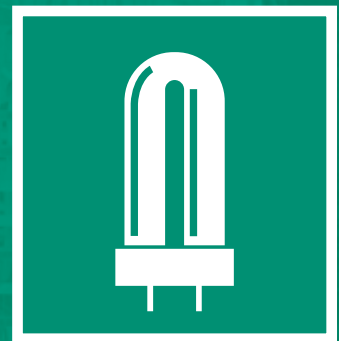

CFL PLUG-IN



PLUG-IN CFL LAMPS

PLUG-IN COMPACT FLUORESCENT LIGHT BULBS ARE USED IN A WIDE VARIETY OF APPLICATIONS. PLUG-IN CFLS ARE MOST COMMONLY USED IN CAN LIGHTS, SCONCES, AND ACCENT LIGHTING. THEY CAN ALSO BE FOUND IN SECURITY LIGHTS, EXIT SIGNS, TROFFER FIXTURES, AND DECORATIVE WALL WASHERS. SPECIALLY DESIGNED PLUG-IN CFL LIGHT BULBS ARE ALSO USED IN HIGH-END READING AND TASK LAMPS.

THERE ARE FOUR GENERAL STYLES OF PLUG-IN FLUORESCENT LIGHT BULBS: TWIN TUBES, QUAD TUBES FOUND WITH BOTH 2 & 4 PINS, TRIPLE TUBES, AND LINEARS.

TWIN TUBE PLUG-INS:

These lamps consist of either two separate parallel tubes, a single U-shaped tube, or two parallel tubes joined near the top of the bulb. Twin Tube Plug-In Fluorescents have either a G23 or GX23 base depending on the wattage. Some high-end reading and task lamps use a Twin Tube Plug-In Fluorescent with a base specific to the manufacturer of the lamp (to prevent interchangeability between brands). They are often found in can lights, accent lighting, sconces, wall washers, security lights, and exit lights.

2-PIN QUAD TUBE PLUG-INS:

These lamps consist of either 4 separate tubes aligned in a 2x2 pattern, or two U-shaped tubes aligned back-to-back. All 2-Pin Quad Tube Plug-In Fluorescent light bulbs operate on magnetic ballasts. These Quad Tube Plug-In Fluorescents have G23d-2, GX23-2, G24d-1, G24d-2, or G24d-3 bases (depending on the wattage). They are often found in can lights, sconces, wall washers, and security lighting.

4-PIN QUAD TUBE PLUG-INS:

These lamps consist of either 4 separate tubes aligned in a 2x2 pattern, or two U-shaped tubes aligned back-to-back. All 4-Pin Quad Tube Plug-In Fluorescent light bulbs operate on electronic ballasts. These 4-Pin Quad Tube Plug-In Fluorescents have G24Q-1, G24Q-2, or G24Q-3 bases depending on wattage. They are often found in can lights, sconces, wall washers, and security lighting.

TRIPLE TUBE PLUG-INS:

These lamps consist of either three U-shaped tubes aligned back-to-back, or three U-shaped tubes aligned in a triangular formation. All Triple Tube Plug-In Fluorescent light bulbs operate on electronic ballasts. These Triple Tube Plug-In Fluorescents have GX24Q-2, GX24Q-3, GX24Q-4, GX24Q-5, or GX24Q-6 bases depending on wattage. They are found in can lights, sconces, wall washers, and security lighting.

LINEAR PLUG-INS:

These lamps consist of either two separate parallel tubes, a single U-shaped tube, or two parallel tubes joined near the top of the bulb, and have 4 pins on the base lined up in a row. All Linear Plug-In Fluorescent light bulbs operate on electronic ballasts. 2G11 bases are utilized for all Linear Plug-In Fluorescent light bulbs (regardless of wattage). They are found in troffer fixtures, wall washer fixtures, retail track lighting, and menu boards.

B
U
L
B
T
Y
P
E
S

What's With All The Different Bases?

Plug-in CFLs require a ballast to operate. The ballasts that operate plug-in CFLs are generally located inside the fixture. Each ballast is designed to run only a specific wattage and varies from fixture to fixture depending on the specific use and light output requirement of the fixture. That's why these bulbs have unique base types specific to the wattage of the light bulb. The base type will determine the type of socket that will accept the light bulb base. Each ballast type requires the fixture to have a different socket type so that only bulbs with the wattage the fixture was designed for may be used for each fixture. Plug-in CFLs with 2 pins operate on magnetic ballasts, while 4-pin plug-ins operate on electronic ballasts. Magnetic ballasts are becoming less common and more expensive, and new plug-in CFL fixtures are all made with electronic ballasts.

PHONE / 718.768.7000

FAX / 718.768.0970

WWW.SUNLITE.COM

G24Q1

9 Watt Compact Fluorescent Plug-In

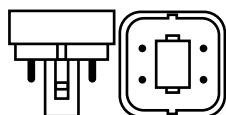

G24Q2

18 Watt Compact Fluorescent Plug-In

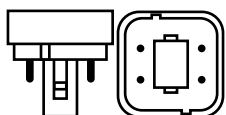

G24Q3

26 Watt Compact Fluorescent Plug-In

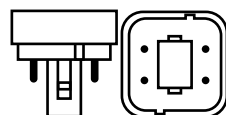

GX24Q1

13 Watt Compact Fluorescent Plug-In

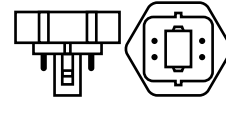

G24D1

9, 13 Watt Compact Fluorescent Plug-In

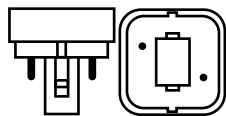

G24D2

18 Watt Compact Fluorescent Plug-In

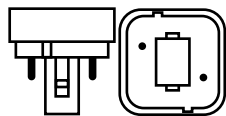

G24D3

26 Watt Compact Fluorescent Plug-In

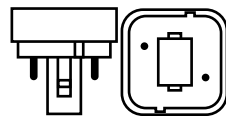

GX24Q2

18 Watt Compact Fluorescent Plug-In

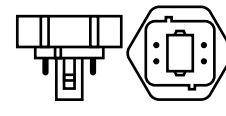

G23-2

9 Watt Compact Fluorescent Plug-In

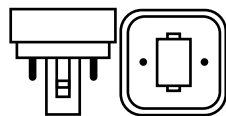

GX32D2

22 Watt Compact Fluorescent Plug-In

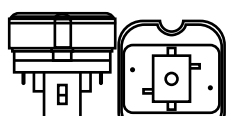

GX32D3

27,28 Watt Compact Fluorescent Plug-In

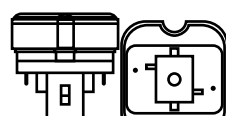

GX24Q3

26, 32 Watt Compact Fluorescent Plug-In

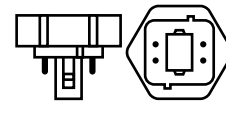

GX23-2

13 Watt Compact Fluorescent Plug-In

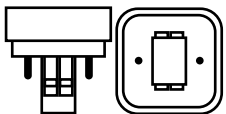

G23

5, 7, 9 Watt Compact Fluorescent Plug-In

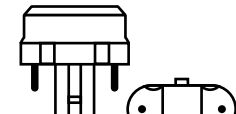

GX23

13 Watt Compact Fluorescent Plug-In

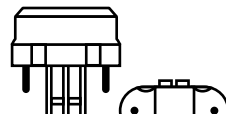

GX24Q4

42 Watt Compact Fluorescent Plug-In

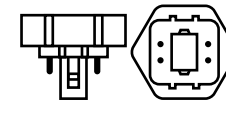

2G11

FT Compact Fluorescent Plug-In Tubes

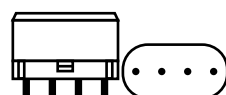

2GX7

13 Watt Compact Fluorescent Plug-In

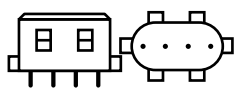

216QA

FUL Compact Fluorescent Plug-In



GX10Q4

27 Watt Compact Fluorescent Plug-In

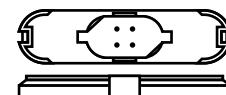



PL | 2-PIN SINGLE U-SHAPED TWIN TUBE

Base	Watts	Item	Description	Lumens	Hours	Color	Kelvin	MOL	Pkg.	Features
4-Pin (G23)	5	60000-SU	PL5/SP27K	210	10,000	Warm White	2700K	4.20"	50	
		60010-SU	PL5/SP41K	210	10,000	Cool White	4100K	4.41"	50	
	7	60020-SU	PL7/SP27K	360	10,000	Warm White	2700K	5.37"	50	
		60025-SU	PL7/SP35K	360	10,000	Neutral White	3500K	5.25"	50	
		60030-SU	PL7/SP41K	360	10,000	Cool White	4100K	5.44"	50	
		60040-SU	PL9/SP27K	530	10,000	Warm White	2700K	6.68"	50	
	9	60045-SU	PL9/SP30K	530	10,000	Warm White	3000K	6.46"	50	
		60050-SU	PL9/SP35K	530	10,000	Neutral White	3500K	6.61"	50	
		60060-SU	PL9/SP41K	530	10,000	Cool White	4100K	6.46"	50	
		60280-SU	PL9/B		10,000	Blue		6.50"	50	■
		60290-SU	PL9/G		10,000	Green		6.50"	50	■
		60300-SU	PL9/R		10,000	Red		6.50"	50	■
	13	60070-SU	PL13/SP27K	720	10,000	Warm White	2700K	7.00"	50	
		60075-SU	PL13/SP30K	720	10,000	Warm White	3000K	7.13"	50	
		60080-SU	PL13/SP35K	720	10,000	Neutral White	3500K	7.07"	50	
		60090-SU	PL13/SP41K	720	10,000	Cool White	4100K	7.10"	50	
		60095-SU	PL13/SP50K	720	10,000	Super White	5,000K	7.08"	50	
		60096-SU	PL13/SP65K	720	10,000	Daylight	6500K	7.02"	50	
60097-SU		PL13/BUG	720	10,000	Yellow		7.22"	50	■	

PL | 4-PIN SINGLE U-SHAPED TWIN TUBE

Base	Watts	Item	Description	Lumens	Hours	Color	Kelvin	MOL	Pkg.	Features
4-Pin (2GX7)	13	60003-SU	PL13/E/SP27K	720	10,000	Warm White	2700K	6.23"	50	
		60005-SU	PL13/E/SP30K	720	10,000	Warm White	3000K	6.44"	50	
		60007-SU	PL13/E/SP35K	720	10,000	Neutral White	3500K	6.22"	50	
		60013-SU	PL13/E/SP41K	720	10,000	Cool White	4100K	6.35"	50	

PLD | 2-PIN DOUBLE U-SHAPED TWIN TUBE

Base	Watts	Item	Description	Lumens	Hours	Color	Kelvin	MOL	Pkg.	Features
2-Pin (G23-2)	9	60310-SU	PLD9/SP27K	525	10,000	Warm White	2700K	4.28"	25	
		60313-SU	PLD9/SP30K	525	10,000	Warm White	3000K	4.34"	25	
		60315-SU	PLD9/SP35K	525	10,000	Neutral White	3500K	4.28"	25	
2-Pin (GX23-2)	13	60130-SU	PLD13/SP27K	660	10,000	Warm White	2700K	4.61"	25	
		60135-SU	PLD13/SP30K	660	10,000	Warm White	3000K	4.66"	25	
		60140-SU	PLD13/SP35K	660	10,000	Neutral White	3500K	4.66"	25	
		60150-SU	PLD13/SP41K	660	10,000	Cool White	4100K	4.66"	25	
		60151-SU	PLD13/SP50K	660	10,000	Super White	5,000K	4.66"	25	
60152-SU	PLD13/SP65K	660	10,000	Daylight	6500K	4.66"	25			

PLD | 2-PIN DOUBLE U-SHAPED TWIN TUBE (CONTINUED)

Base	Watts	Item	Description	Lumens	Hours	Color	Kelvin	MOL	Pkg.	Features
2-Pin (G24d2)	18	60190-SU	PLD18/SP27K	1080	10,000	Warm White	2700K	6.07"	25	
		60195-SU	PLD18/SP30K	1080	10,000	Warm White	3000K	6.12"	25	
		60200-SU	PLD18/SP35K	1080	10,000	Neutral White	3500K	6.12"	25	
		60211-SU	PLD18/SP50K	1080	10,000	Super White	5,000K	6.12"	25	
		60212-SU	PLD18/SP65K	1080	10,000	Daylight	6500K	6.12"	25	
2-Pin (G24d3)	26	60250-SU	PLD26/SP27K	1560	10,000	Warm White	2700K	6.78"	25	
		60255-SU	PLD26/SP30K	1560	10,000	Warm White	3000K	6.68"	25	
		60260-SU	PLD26/SP35K	1560	10,000	Neutral White	3500K	6.78"	25	
		60270-SU	PLD26/SP41K	1560	10,000	Cool White	4100K	6.78"	25	
		60272-SU	PLD26/SP65K	1560	10,000	Daylight	6500K	6.68"	25	

PLD | 4-PIN DOUBLE U-SHAPED TWIN TUBE

Base	Watts	Item	Description	Lumens	Hours	Color	Kelvin	MOL	Pkg.	Features
4-Pin (G24q1)	13	60100-SU	PLD13/E/SP27K	780	10,000	Warm White	2700K	5.01"	25	
		60105-SU	PLD13/E/SP30K	780	10,000	Warm White	3000K	5.23"	25	
		60110-SU	PLD13/E/SP35K	780	10,000	Neutral White	3500K	5.05"	25	
		60120-SU	PLD13/E/SP41K	780	10,000	Cool White	4100K	5.04"	25	
		60121-SU	PLD13/E/SP50K	780	10,000	Super White	5,000K	5.01"	25	
		60122-SU	PLD13/E/SP65K	780	10,000	Daylight	6500K	5.20"	25	
4-Pin (G24q2)	18	60160-SU	PLD18/E/SP27K	1080	10,000	Warm White	2700K	5.64"	25	
		60165-SU	PLD18/E/SP30K	1080	10,000	Warm White	3000K	5.78"	25	
4-Pin (G24-q2)	18	60170-SU	PLD18/E/SP35K	1080	10,000	Neutral White	3500K	5.79"	25	
		60180-SU	PLD18/E/SP41K	1200	10,000	Cool White	4100K	5.62"	25	
		60181-SU	PLD18/E/SP50K	1080	10,000	Super White	5,000K	5.64"	25	
		60182-SU	PLD18/E/SP65K	1080	10,000	Daylight	6500K	5.85"	25	
4-Pin (G24q3)	26	60220-SU	PLD26/E/SP27K	1560	10,000	Warm White	2700K	6.49"	25	
		60225-SU	PLD26/E/SP30K	1560	10,000	Warm White	3000K	6.49"	25	
		60230-SU	PLD26/E/SP35K	1560	10,000	Neutral White	3500K	6.43"	25	
		60240-SU	PLD26/E/SP41K	1560	10,000	Cool White	4100K	6.43"	25	
		60241-SU	PLD26/E/SP50K	1560	10,000	Super White	5,000K	6.53"	25	
		60242-SU	PLD26/E/SP65K	1560	10,000	Daylight	6500K	6.43"	25	

PLT | 4-PIN TRIPLE TUBE

Base	Watts	Item	Description	Lumens	Hours	Color	Kelvin	MOL	Pkg.	Features
4-Pin (GX24q3)	18	60500-SU	PLT18/E/SP27K	1200	10,000	Warm White	2700K	4.37"	25	
		60510-SU	PLT18/E/SP35K	1200	10,000	Neutral White	3500K	4.55"	25	
		60515-SU	PLT18/E/SP41K	1200	10,000	Cool White	4100K	4.61"	25	



PLT | 4-PIN TRIPLE TUBE (CONTINUED)

Base	Watts	Item	Description	Lumens	Hours	Color	Kelvin	MOL	Pkg.	Features
4-Pin (GX24q3)	26	60520-SU	PLT26/E/SP27K	1800	10,000	Warm White	2700K	4.98"	25	
		60525-SU	PLT26/E/SP30K	1800	10,000	Warm White	3000K	4.96"	25	
		60530-SU	PLT26/E/SP35K	1800	10,000	Neutral White	3500K	5.03"	25	
		60535-SU	PLT26/E/SP41K	1800	10,000	Cool White	4100K	5.15"	25	
		60536-SU	PLT26/E/SP50K	1800	10,000	Super White	5,000K	4.95"	25	
		60537-SU	PLT26/E/SP65K	1800	10,000	Daylight	6500K	4.95"	25	
	32	60540-SU	PLT32/E/SP27K	2400	10,000	Warm White	2700K	5.74"	25	
		60545-SU	PLT32/E/SP30K	2400	10,000	Warm White	3000K	5.76"	25	
		60550-SU	PLT32/E/SP35K	2400	10,000	Neutral White	3500K	5.74"	25	
		60555-SU	PLT32/E/SP41K	2400	10,000	Cool White	4100K	5.43"	25	
		60556-SU	PLT32/E/SP50K	2400	10,000	Super White	5,000K	5.75"	25	
		60557-SU	PLT32/E/SP65K	2400	10,000	Daylight	6500K	5.74"	25	
4-Pin GX24q4	42	60560-SU	PLT42/E/SP27K	3200	10,000	Warm White	2700K	6.47"	25	
		60565-SU	PLT42/E/SP30K	3200	10,000	Warm White	3000K	6.47"	25	
		60570-SU	PLT42/E/SP35K	3200	10,000	Neutral White	3500K	6.39"	25	
		60575-SU	PLT42/E/SP41K	3200	10,000	Cool White	4100K	6.45"	25	
		60576-SU	PLT42/E/SP50K	3200	10,000	Super White	5,000K	6.45"	25	
		60577-SU	PLT42/E/SP65K	3200	10,000	Daylight	6500K	6.49"	25	



FUL | 4-PIN SINGLE U-SHAPED TWIN TUBE

Base	Watts	Item	Description	Lumens	Hours	Color	Kelvin	MOL	Pkg.	Features
4-Pin (GX10q)	8	05145-SU	FUL8T6/BL		5,000	Black Light		5.75"	12	■
	13	05110-SU	FUL13T6/CW	505	5,000	Cool White	4100K	7.85"	10	
	15	05155-SU	FUL15T6/BL		5,000	Black Light		7.86"	12	■
	18	05160-SU	FUL18T6/bl		5,000	Black Light		9.06"	10	■
	25	05165-SU	FUL25T8/BL		5,000	Black Light		9.38"	12	■
	40	05175-SU	FUL40T10/BL		5,000	Black Light		11.89"	12	■
		05170-SU	FUL40T8/BL		5,000	Black Light		12.15"	12	■
	50	05180-SU	FUL50T10/BL		5,000	Black Light		14.75"	12	■
	12	05150-SU	FUL12T6/BL		5,000	Black Light		6.33"	12	■
		05100-SU	FUL12T6/CW	505	5,000	Cool White	4100K	6.24"	12	



FDL | 2-PIN QUAD TUBE

Base	Watts	Item	Description	Lumens	Hours	Color	Kelvin	MOL	Pkg.	Features
2-Pin (GX32d2)	22	05750-SU	FDL22/30K	1050	10,000	Warm White	3000K	6.17"	25	
		05755-SU	FDL22/50K	1050	10,000	Super White	5,000K	6.10"	25	
2-Pin (GX32d3)	28	05760-SU	FDL28/30K	1350	10,000	Warm White	3000K	6.65"	25	
		05765-SU	FDL28/50K	1350	10,000	Super White	5,000K	6.38"	25	



FML | 4-PIN QUAD TUBE

Base	Watts	Item	Description	Lumens	Hours	Color	Kelvin	MOL	Pkg.	Features
4-Pin (GX10q4)	27	05770-SU	FML27/30K/CD1	1500	10,000	Warm White	3000K	5.62"	12	
		05773-SU	FML27/65K	1500	10,000	Daylight	6500K	5.43"	12	



FT | 4-PIN TWIN TUBE

Base	Watts	Item	Description	Lumens	Hours	Color	Kelvin	MOL	Pkg.	Features
4-Pin (2G11)	18	02165-SU	FT18DL/830	1200	10,000	Warm White	3000K	9.02"	10	
		02170-SU	FT18DL/835	1200	10,000	Neutral White	3500K	8.74"	10	
		02175-SU	FT18DL/841	1200	10,000	Cool White	4100K	9.02"	10	
4-Pin (2G11)	24	02180-SU	FT24DL/830	1800	10,000	Warm White	3000K	12.69"	10	
		02185-SU	FT24DL/835	1800	10,000	Neutral White	3500K	12.69"	10	
		02190-SU	FT24DL/841	1800	10,000	Cool White	4100K	12.69"	10	
	36	02115-SU	FT36DL/830	2900	10,000	Warm White	3000K	16.44"	10	
		02120-SU	FT36DL/835	2900	10,000	Neutral White	3500K	16.14"	10	
		02125-SU	FT36DL/841	2900	10,000	Cool White	4100K	16.44"	10	
40	02130-SU	FT40DL/830/RS	3150	10,000	Warm White	3000K	22.50"	10		
	02135-SU	FT40DL/835/RS	3150	10,000	Neutral White	3500K	22.40"	10		
	02140-SU	FT40DL/841/RS	3150	10,000	Cool White	4100K	22.50"	10		
	02141-SU	FT40DL/850/RS	3150	10,000	Super White	5,000K	22.50"	10		
50	02142-SU	FT40DL/865/RS	3150	12,000	Daylight	6500K	22.50"	10		
	02100-SU	FT50DL/830	4200	10,000	Warm White	3000K	22.56"	10		
	02105-SU	FT50DL/835	4200	10,000	Neutral White	3500K	22.56"	10		
		02110-SU	FT50DL/841	4200	10,000	Cool White	4100K	22.56"	10	

PHONE / 718.768.7000

FAX / 718.768.0970

WWW.SUNLITE.COM

sunlite



LINEAR FLUORESCENT



FLUORESCENT LAMPS

A FLUORESCENT LAMP IS A GAS-ENCLOSED TUBE THAT USES ELECTRICITY TO STIMULATE MERCURY VAPORS INTO VISIBLE LIGHT. HERE'S HOW:

HOW IT WORKS

A fluorescent lamp tube is filled with a gas containing low pressure mercury vapor and argon, xenon, neon, or krypton. When fluorescent lamps are turned on, the electric power heats up the electrodes enough for it to emit electrons. The electrons clash with atoms in the gas. If the free electron has enough kinetic energy, it transfers energy to the atom's outer electron, causing that electron to temporarily increase its energy level. When the electrons decrease its energy level, the energy discharged are light particles called photons.

Photons are ultraviolet light and are not visible to the human eye, so they must be converted into visible light. The process of making ultraviolet photons visible to the human eye is the same process as creating photons.

A Fluorescent coating is placed on the inner surface of the tube. The coating is made of varying blends of metallic and rare-earth phosphor salts. Ultraviolet photons are absorbed by electrons in the atoms of the lamp's interior fluorescent coating, causing a similar energy jump, then drop, with emission of a further photon. The photon that is emitted from this second interaction has a lower energy than the one that caused it. The chemicals that make up the phosphor are chosen so that these emitted photons are at wavelengths visible to the human eye.

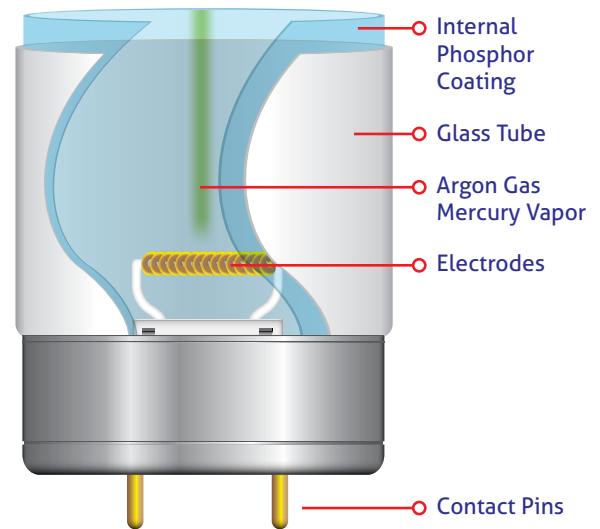

1

Electron shift energy levels, consequently creating light particles called Photons

2

The mercury reacts and emits ultraviolet light.

3

The phosphor converts the transformed light into visible light.

STANDARD FLUORESCENT vs. HIGH OUTPUT FLUORESCENT

Standard & HO fluorescent lamps are similar in how they work - although each type has unique features and requires different ballasts in order to work.

STANDARD

- Wide Spectral Variety
- Low Initial Cost
- Energy Efficient
- Minimal Heat Output

HIGH OUTPUT

- Greater Light Output
- Higher Kelvin Temperatures
- Higher Energy Consumption
- Longer Bulb Life
- Increased Heat Production

BLACK LIGHT VS. BLACK LIGHT BLUE

THE MECHANICS OF BLACK LIGHTS IS THE SAME AS STANDARD FLUORESCENT LAMP. THEY DIFFER, HOWEVER, IN THE COMPOSITION OF PHOSPHOR.

Black Lights discharge the major portion of their energy in the ultraviolet radiation region (peaking in the 356.0nm, 375.0nm), along with little amounts of visible light. Since the major part of the light that it emits is ultraviolet, when turned on, the lamp radiates a light purplish color.

Black Light Blues are designed with a special dark-blue optical filtering material glass. This material absorbs almost all visible light causing the light being emitted to be mostly ultraviolet light. When turned on, the bulb produces a dark purplish ultraviolet color.

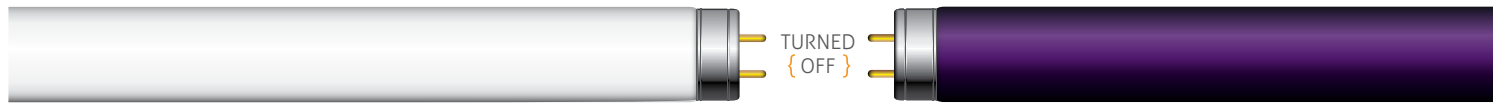

COLOR RENDERING

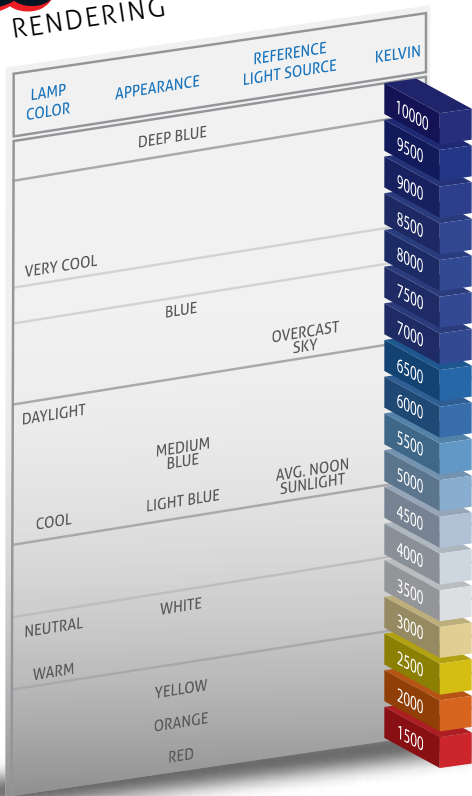

CRI RATING

A percentage equivalent rating on how close a fluorescent lamp renders light compared to a natural light source.

- DAYLIGHT FLUORESCENT..... 84 CRI
- CLEAR MERCURY VAPOR..... 15-55 CRI
- DAYLIGHT METAL HALIDE..... 70-80 CRI
- DELUXE WHITE MERCURY VAPOR..... 32-50 CRI
- SUPER WHITE WHITE FLUORESCENT..... C60-90 CRI
- CLEAR METAL HALIDE..... 65-80 CRI
- COOL WHITE FLUORESCENT..... 70-80 CRI
- SELF-BALLASTED MERCURY VAPOR..... 50 CRI
- WARM WHITE METAL HALIDE..... 65 CRI
- QUARTZ HALOGEN..... 80 CRI
- 3000K FLUORESCENT..... 70-80 & 52 CRI
- INCANDESCENT..... 99+ CRI
- HIGH PRESSURE SODIUM..... 22-70 CRI
- LOW PRESSURE SODIUM..... 0-18 CRI

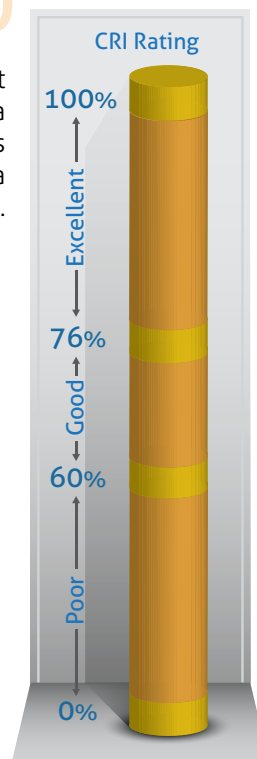

LAMP SIZES (ACTUAL SIZES)

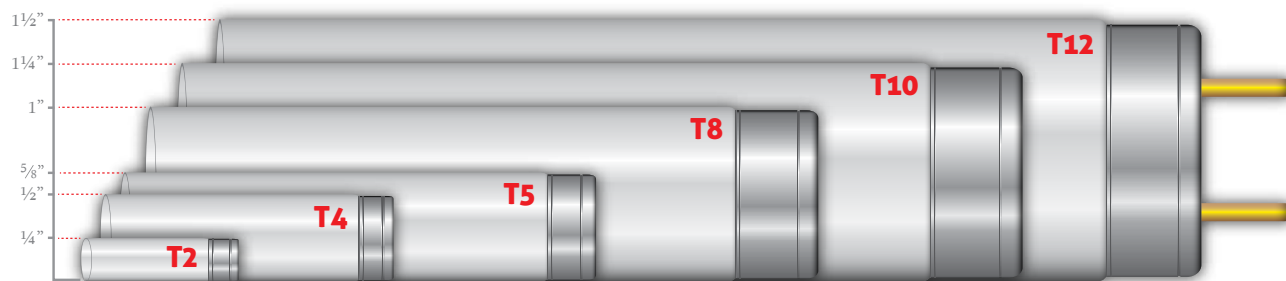



T5 STRAIGHT TUBE

Base	Watts	Item	Description	Color	Kelvin	Lumens	CRI	Hours	MOL	Pkg.	Features
Mini Bi-Pin (G5)	4	05040-SU	F4T5/CW	Cool White	4100K	135	62	6,000	6.00"	10	
		05045-SU	F4T5/WW	Warm White	2700K	140	62	6,000	6.00"	10	
	6	05050-SU	F6T5/CW	Cool White	4100K	240	62	6,000	9.00"	10	
		05051-SU	F6T5/DL	Daylight	6500K	210	62	6,000	9.00"	10	
	8	05060-SU	F8T5/CW	Cool White	4100K	350	62	6,000	12.00"	10	
		05061-SU	F8T5/DL	Daylight	6500K	310	62	6,000	12.00"	10	
		05065-SU	F8T5/WW	Warm White	2700K	380	62	6,000	12.00"	10	
	13	05070-SU	F13T5/CW	Cool White	4100K	850	82	6,000	21.00"	10	
		05071-SU	F13T5/DL	Daylight	6500K	750	82	6,000	21.00"	10	
		05075-SU	F13T5/WW	Warm White	2700K	920	82	6,000	21.00"	10	



T5 HIGH PERFORMANCE STRAIGHT TUBE

Base	Watts	Item	Description	Color	Kelvin	Lumens	CRI	Hours	MOL	Pkg.	Features
Mini Bi-Pin (G5)	14	30300-SU	F14T5/830	Warm White	3000K	1200	82	20,000	22.20"	40	
		30251-SU	F14T5/835/12PK	Neutral White	3500K	1200	83	20,000	22.20"	12	
		30305-SU	F14T5/835	Neutral White	3500K	1200	82	20,000	22.20"	40	
		30252-SU	F14T5/841/12PK	Cool White	4100K	1200	83	20,000	22.20"	12	
		30310-SU	F14T5/841	Cool White	4100K	1200	82	20,000	22.20"	40	
		30314-SU	F14T5/865	Daylight	6500K	1200	82	20,000	22.20"	40	
	21	30315-SU	F21T5/830	Warm White	3000K	1900	82	20,000	34.00"	40	
		30253-SU	F21T5/835/12PK	Neutral White	3500K	1900	82	20,000	34.00"	12	
		30320-SU	F21T5/835	Neutral White	3500K	1900	82	20,000	34.00"	40	
		30254-SU	F21T5/841/12PK	Cool White	4100K	1900	82	20,000	34.00"	12	
		30325-SU	F21T5/841	Cool White	4100K	1900	82	20,000	34.00"	40	
		30322-SU	F21T5/850	Super White	5000K	1900	82	20,000	34.00"	40	
	28	30324-SU	F21T5/865	Daylight	6500K	1900	82	20,000	34.00"	40	
		30330-SU	F28T5/830	Warm White	3000K	2500	82	20,000	45.80"	40	
		30255-SU	F28T5/835/12PK	Neutral White	3500K	2500	82	20,000	45.80"	12	
		30335-SU	F28T5/835	Neutral White	3500K	2500	82	20,000	45.80"	40	
		30256-SU	F28T5/841/12PK	Cool White	4100K	2500	82	20,000	45.80"	12	
		30340-SU	F28T5/841	Cool White	4100K	2500	82	20,000	45.80"	40	
	35	30342-SU	F28T5/850	Super White	5000K	2500	82	20,000	45.80"	40	
		30345-SU	F28T5/865	Daylight	6500K	2500	82	20,000	45.80"	40	
		30385-SU	F35T5/830	Warm White	3000K	3100	82	20,000	57.60"	40	
		30390-SU	F35T5/841	Cool White	4100K	3100	82	20,000	57.60"	40	
		30392-SU	F35T5/850	Super White	5000K	3100	82	20,000	57.60"	40	
		30395-SU	F35T5/865	Daylight	6500K	3100	82	20,000	57.60"	40	

T5 HIGH OUTPUT HIGH PERFORMANCE STRAIGHT TUBE



Base	Watts	Item	Description	Color	Kelvin	Lumens	CRI	Hours	MOL	Pkg.	Features
Mini Bi-Pin (G5)	24	30400-SU	F24T5/830/HO	Warm White	3000K	1800	82	20,000	22.20"	40	
		30405-SU	F24T5/835/HO	Neutral White	3500K	1800	82	20,000	22.20"	40	
		30410-SU	F24T5/841/HO	Cool White	4100K	1800	82	20,000	22.20"	40	
		30412-SU	F24T5/850/HO	Super White	5000K	1800	82	20,000	22.20"	40	
		30413-SU	F24T5/850/HO	Super White	5000K	1800	82	20,000	22.00"	40	
		30414-SU	F24T5/865/HO	Daylight	6500K	1800	82	20,000	22.20"	40	
	39	30415-SU	F39T5/830/HO	Warm White	3000K	3100	82	20,000	34.00"	40	
		30420-SU	F39T5/835/HO	Neutral White	3500K	3100	82	20,000	34.00"	40	
		30425-SU	F39T5/841/HO	Cool White	4100K	3100	82	20,000	34.00"	40	
		30427-SU	F39T5/850/HO	Super White	5000K	3100	82	20,000	34.00"	40	
		30429-SU	F39T5/865/HO	Daylight	6500K	3100	82	20,000	34.00"	40	
	54	30430-SU	F54T5/830/HO	Warm White	3000K	5000	82	20,000	45.80"	40	
		30257-SU	F54T5/835/HO/12PK	Neutral White	3500K	5000	82	20,000	45.80"	12	
		30435-SU	F54T5/835/HO	Neutral White	3500K	5000	82	20,000	45.80"	40	
		30258-SU	F54T5/841/HO/12PK	Cool White	4100K	5000	82	20,000	45.80"	12	
		30440-SU	F54T5/841/HO	Cool White	4100K	5000	82	20,000	45.80"	40	
		30259-SU	F54T5/850/HO/12PK	Soft White	5000K	5000	82	20,000	45.80"	12	
		30445-SU	F54T5/850/HO	Super White	5000K	5000	82	20,000	45.80"	40	
		30450-SU	F54T5/865/HO	Daylight	6500K	5000	82	20,000	45.80"	40	
30441-SU	F54T5/841/HO	Cool White	4100K	5000	82	20,000	45.80"	40			



T5 COLORED STRAIGHT TUBE

Base	Watts	Item	Description	Color	Kelvin	Lumens	CRI	Hours	MOL	Pkg.	Features
Mini Bi-Pin (G5)	28	30350-SU	F28T5/B	Blue		700		20,000	45.80"	40	■
		30355-SU	F28T5/G	Green		3500		20,000	45.80"	40	■
		30360-SU	F28T5/R	Red		2100		20,000	45.80"	40	■
	54	30370-SU	F54T5/B/HO	Blue		1150		20,000	45.80"	40	■
		30375-SU	F54T5/G/HO	Green		5500		20,000	45.80"	40	■
		30380-SU	F54T5/R/HO	Red		3300		20,000	45.80"	40	■



T5 SINGLE DOUBLE CIRCLINE

Base	Watts	Item	Description	Color	Kelvin	Lumens	CRI	Hours	MOL	Pkg.	Features
4-Pin (GU10Q)	40	05740-SU	FC40/2C/30K	Warm White	3000K	2800	82	10,000	7.55"	12	
		05745-SU	FC40/2C/41K	Cool White	4100K	2800	82	10,000	7.55"	12	



T5 DOUBLE CIRCLINE

Base	Watts	Item	Description	Color	Kelvin	Lumens	CRI	Hours	MOL	Pkg.	Features
4-Pin (2GX13)	22	05800-SU	FC22T5/SP830	Warm White	3000K	1900	82	10,000	8.86"	12	
		05805-SU	FC22T5/SP835	Neutral White	3500K	1900	82	10,000	8.86"	12	
		05810-SU	FC22T5/SP841	Cool White	4100K	1900	82	10,000	8.86"	12	
	40	05815-SU	FC40T5/SP830	Warm White	3000K	3350	82	10,000	11.77"	12	
		05820-SU	FC40T5/SP835	Neutral White	3500K	3350	82	10,000	11.77"	12	
		05825-SU	FC40T5/SP841	Cool White	4100K	3350	82	10,000	11.77"	12	



2D LAMP

Base	Watts	Item	Description	Color	Kelvin	Lumens	CRI	Hours	MOL	Pkg.	Features
4-Pin (GR10Q)	16	05720-SU	F16/2D/827/4P	Warm White	2700K	1050	82	10,000	5.55"	24	
		05725-SU	F16/2D/835/4P	Neutral White	3500K	1050	82	10,000	5.55"	24	
	21	05730-SU	F21/2D/827/4P	Warm White	2700K	1300	82	10,000	5.55"	12	
		05735-SU	F21/2D/835/4P	Neutral White	3500K	1300	82	10,000	5.55"	12	
	28	05700-SU	F28/2D/827/4P	Warm White	2700K	1900	82	10,000	8.15"	12	
		05705-SU	F28/2D/835/4P	Neutral White	3500K	1900	82	10,000	8.15"	12	
	38	05710-SU	F38/2D/827/4P	Warm White	2700K	2400	82	10,000	8.15"	12	
		05715-SU	F38/2D/835/4P	Neutral White	3500K	2400	82	10,000	8.15"	12	



T8 STRAIGHT TUBE

Base	Watts	Item	Description	Color	Kelvin	Lumens	CRI	Hours	MOL	Pkg.	Features
Medium 2-Pin (G13)	14	05078-SU	F14T8/CW	Cool White	4100K	550	62	8,000	15.00"	30	
	15	05080-SU	F15T8/CW	Cool White	4100K	610	62	7,000	18.00"	30	
		05085-SU	F15T8/DL	Daylight	6500K	560	62	7,000	18.00"	30	



T8 HIGH PERFORMANCE STRAIGHT TUBE

Base	Watts	Item	Description	Color	Kelvin	Lumens	CRI	Hours	MOL	Pkg.	Features
Medium 2-Pin (G13)	25	30130-SU	F25T8/SP730	Warm White	3000K	2150	73	20,000	36.00"	30	
		30151-SU	F25T8/SP750	Super White	5000K	2150	73	20,000	36.00"	30	
700 Series	32	30160-SU	F32T8/SP730	Warm White	3000K	2850	73	20,000	48.00"	30	
		30185-SU	F32T8/SP750	Super White	5000K	2850	73	20,000	48.00"	30	
800 Series	17	30105-SU	F17T8/SP830	Warm White	3000K	1400	83	20,000	24.00"	30	
		30240-SU	F17T8/SP835/10PK	Neutral White	3500K	1450	83	20,000	24.00"	10	
		30115-SU	F17T8/SP835	Neutral White	3500K	1450	83	20,000	24.00"	30	
		30241-SU	F17T8/SP841/10PK	Cool White	4100K	1450	83	20,000	24.00"	10	
	17	30125-SU	F17T8/SP841	Cool White	4100K	1450	83	20,000	24.00"	30	
		30126-SU	F17T8/SP850/30PK	Soft White	5000K	1400	83	20,000	24.00"	30	
		30128-SU	F17T8/SP865/30PK	Daylight	6500K	1400	83	20,000	24.00"	30	



T8 HIGH PERFORMANCE STRAIGHT TUBE (CONTINUE)

Base	Watts	Item	Description	Color	Kelvin	Lumens	CRI	Hours	MOL	Pkg.	Features
Medium 2-Pin (G13)	25	30135-SU	F25T8/SP830	Warm White	3000K	2300	83	20,000	36.00"	30	
		30242-SU	F25T8/SP835/10PK	Neutral White	3500K	2300	83	20,000	36.00"	10	
		30145-SU	F25T8/SP835	Neutral White	3500K	2300	83	20,000	36.00"	30	
		30243-SU	F25T8/SP841/10PK	Cool White	4100K	2300	83	20,000	36.00"	10	
		30155-SU	F25T8/SP841	Cool White	4100K	2300	83	20,000	36.00"	30	
		30158-SU	F25T8/SP850/30PK	Soft White	5000K	2300	83	20,000	36.00"	30	
		30159-SU	F25T8/SP865/30PK	Daylight	6500K	2300	83	20,000	36.00"	30	
	28	30166-SU	F28T8/SP830	Warm White	3000K	2400	83	20,000	48.00"	30	
		30176-SU	F28T8/SP835	Neutral White	3500K	2400	83	20,000	48.00"	30	
		30177-SU	F28T8/SP841	Cool White	4100K	2400	83	20,000	48.00"	30	
		30178-SU	F28T8/SP850	Super White	5000K	2400	83	20,000	48.00"	30	
	32	30165-SU	F32T8/SP830	Warm White	3000K	3050	83	24,000	48.00"	30	
		30244-SU	F32T8/SP835/10PK	Neutral White	3500K	3050	83	20,000	48.00"	10	
		30175-SU	F32T8/SP835	Neutral White	3500K	3050	83	24,000	48.00"	30	
		30170-SU	F32T8/SP735	Neutral White	3500K	2850	73	20,000	48.00"	30	
		30195-SU	F32T8/SP841	Cool White	4100K	3050	83	20,000	48.00"	30	
		30199-SU	F32T8/SP850	Super White	5000K	3100	82	24,000	48.00"	30	
		30246-SU	F32T8/SP850/10PK	Soft White	5000K	3050	83	20,000	48.00"	10	
	58	30196-SU	F32T8/SP850	Super White	5000K	3100	83	24,000	48.00"	30	
		30192-SU	F32T8/SP865/30PK	Daylight	6500K	3050	83	20,000	48.00"	30	
30187-SU		F58T8/841	Cool White	4100K	5000	82	24000	59.60"	30		
30188-SU		F58T8/SP835	Neutral White	3500K	5000	83	24,000	59.60"	30		



T8 HIGH LUMEN STRAIGHT TUBE

Base	Watts	Item	Description	Color	Kelvin	Lumens	CRI	Hours	MOL	Pkg.	Features
Medium 2-Pin (G13)	32	30161-SU	F32T8/HL/SP830	Warm White	3000K	3150	82	24000	48.00"	30	
		30163-SU	F32T8/HL/SP841	Cool White	4100K	3150	82	24,000	48.00"	30	
		30164-SU	F32T8/HL/SP850	Super White	5000K	3150	82	24,000	48.00"	30	

T8 & T12 U-BEND TUBE

Base	Watts	Item	Description	Color	Kelvin	Lumens	CRI	Hours	MOL	Pkg.	Features
T8 Mini Bi-Pin (G5) 3 inches	31	30265-SU	FB31/SP830	Warm White	3000K	3000	82	20,000	22.50"	12	
		30270-SU	FB31/SP835	Neutral White	3500K	3000	82	20,000	22.50"	12	
		30275-SU	FB31/SP841	Cool White	4100K	3000	82	20,000	22.50"	12	
T8 Mini Bi-Pin (G5) 6 inches	32	30215-SU	FB32/SP830/6	Warm White	3000K	3000	83	20,000	22.50"	12	
		30220-SU	FB32/SP835/6	Neutral White	3500K	3000	83	20,000	22.50"	12	
		30225-SU	FB32/SP841/6	Cool White	4100K	3000	83	20,000	22.50"	12	
		30212-SU	FB32/SP750/6	Super White	5000K	2750	73	20,000	22.50"	12	
		30230-SU	FB32/SP850/6	Super White	5000K	3000	83	20,000	22.50"	12	
		30235-SU	FB32/SP865/6	Daylight	6500K	3000	83	20,000	22.50"	12	
T12 (2G13) 6 inches	40	30250-SU	FB40CW/U/6	Cool White	4000K	2400		18,000	22.44"	12	
		30260-SU	FB40DX/U/6	Daylight	6500K	2250		18,000	22.44"	12	



T9 CIRCLINE

Base	Watts	Item	Description	Color	Kelvin	Lumens	CRI	Hours	MOL	Pkg.	Features
4-Pin (G10q)	20	05009-SU	FC6T9/CW	Cool White	4100K	1050	62	10,000	6.00"	12	
		05015-SU	FC8T9/CW	Cool White	4100K	1250	62	10,000	8.00"	12	
	22	05027-SU	FC8T9/DL	Daylight	6500K	1050	62	10,000	8.00"	12	
		05026-SU	FC8T9/WW	Warm White	3000K	1250	62	10,000	8.00"	12	
	30	05037-SU	FCL30/30K	Warm White	2700K	2050	80	10,000	9.00"	12	
		05038-SU	FCL30/50K	Super White	5000K	1800	80	10,000	9.00"	12	
	32	05028-SU	FC12T9/CW	Cool White	4100K	2100	62	10,000	12.00"	12	
		05035-SU	FC12T9/DL	Daylight	6500K	1750	62	10,000	12.00"	12	
		05025-SU	FC12T9/WW	Warm White	3000K	2100	62	10,000	11.86"	12	
	40	05021-SU	FC16T9/CW	Cool White	4100K	2600	62	10,000	16.00"	12	
		05022-SU	FC16T9/DL	Daylight	6500K	2600	62	10,000	16.00"	12	
		05023-SU	FC16T9/WW	Warm White	2700K	2600	62	10,000	16.00"	12	



T12 STRAIGHT TUBE

Base	Watts	Item	Description	Color	Kelvin	Lumens	CRI	Hours	MOL	Pkg.	Features
Medium 2-Pin (G13)	15	30000-SU	F15T12/CW	Cool White	4100K	610	62	8,000	18.00"	30	
		30005-SU	F15T12/DL	Daylight	6500K	560	62	8,000	18.00"	30	
	20	30010-SU	F20T12/CW	Cool White	4100K	1150	62	8,000	24.00"	30	
		30015-SU	F20T12/DL	Daylight	6500K	960	62	8,000	24.00"	30	
	30	30020-SU	F30T12/CW	Cool White	4100K	2050	62	8,000	36.00"	30	
		30025-SU	F30T12/DL	Daylight	6500K	1750	62	8,000	36.00"	30	
	40	30031-SU	F40T12/CWX	Cool White	4100K	2550	90	24,000	48.00"	30	
		30032-SU	F40T12/DX	Daylight	6500K	2550	90	24,000	48.00"	30	



T5, T8, T12 BLACK LIGHT & BLACK LIGHT BLUE STRAIGHT TUBE

Base	Watts	Item	Description	Color	Kelvin	Lumens	CRI	Hours	MOL	Pkg.	Features
Mini Bi-Pin (G5)	4	38000-SU	F4T5/BL	Black Light				6,000	6.00"	10	■
	6	38010-SU	F6T5/BL	Black Light				6,000	9.00"	10	■
	8	38020-SU	F8T5/BL	Black Light				6,000	12.00"	10	■
	4	39000-SU	F4T5/BLB	Black Light Blue				6,000	6.00"	10	■
Medium 2-Pin (G13)	10	39030-SU	F10T8/BLB	Black Light Blue				8,000	13.50"	30	■
	15	38040-SU	F15T8/BL	Black Light				8,000	18.00"	30	■
	30	39060-SU	F30T8/BLB	Black Light Blue				4,000	36.00"	25	■
	32	03740-SU	F32T8/BLB	Black Light Blue				20,000	48.00"	30	■

T2 SUB MINIATURE FM

Base	Watts	Item	Description	Color	Kelvin	Lumens	CRI	Hours	MOL	Pkg.	Features
6		26204-S	FM6/830	Warm White	3000K		80	10,000		20	
		26213-S	FM6/841	Cool White	4100K		80	10,000		20	
8		26237-S	FM8/830	Warm White	3000K	540	80	10,000		20	
		26232-S	FM8/841	Cool White	4100K	540	80	10,000		20	
11		26239-S	FM11/830	Warm White	3000K	750	80	10,000		20	
13		26253-S	FM13/830	Warm White	3000K	930	80	10,000		20	
		26291-S	FM13/835	Neutral White	3500K	930	80	10,000		20	

T8 & T12 APPLIANCE TUBE

Base	Watts	Item	Description	Color	Kelvin	Lumens	CRI	Hours	MOL	Pkg.	Features
Medium 2-Pin (G13)	18	23014-S	F18T8/CW/K/24	Cool White	4200K	1190	60	7,500	24.00"	24	
		23027-S	F18T8/CW/K/26	Cool White	4200K	1280	60	7,500	26.00"	24	
		23028-S	F18T8/CW/K/28	Cool White	4200K	1360	60	7,500	28.00"	24	
		23030-S	F18T8/CW/K/30	Cool White	4200K	1400	60	7,500	30.00"	24	
	25	22527-S	F25T12/CW/28	Cool White	4200K	1670	60	7,500	28.00"	30	
		22528-S	F25T12/CW/30	Cool White	4200K	1730	60	7,500	30.00"	30	
		22529-S	F25T12/CW/33	Cool White	4200K	1850	60	7,500	33.00"	30	
		22333-S	F25T12/WW/30	Warm White	3000K	1750	52	7,500	29.78"	30	

T12 STRAIGHT TUBE

Base	Watts	Item	Description	Color	Kelvin	Lumens	CRI	Hours	MOL	Pkg.	Features
Single Pin (Fa6)	30	23618-S	F36T12/CW-SYL	Cool White	4200K	1970	60	7,500	36.00"	30	
	32	24823-S	F48T12/CW/SS	Cool White	4200K	2450	60	9,000	46.00"	24	
	50	26001-S	F60T12/CW	Cool White	4200K	3700	60	12,000	60.00"	30	
		26002-S	F60T12/D	Daylight	6500K	3000	76	12,000	60.00"	30	
	52	26403-S	F64T12/CW	Cool White	4200K	3900	60	12,000		30	
	55	27256-S	F72T12/CW	Cool White	4200K	4500	60	12,000	72.00"	15	
		27259-S	F72T12/D	Daylight	6500K	3800	76	12,000	72.00"	15	
	38	27266-S	F72T8/CW	Cool White	4200K	3050	60	7,500	72.00"	24	
		27270-S	F72T8/WW	Warm White	3000K	3100	52	7,500	72.00"	24	



T12 STRAIGHT TUBE (CONTINUE)

Base	Watts	Item	Description	Color	Kelvin	Lumens	CRI	Hours	MOL	Pkg.	Features
Recessed (R17d)	60	25146-S	F48T12/CW/HO	Cool White	4200K	4050	60	12,000	48.00"	30	
	Single Pin (Fa6)	70	28417-S	F84T12/CW	Cool White	4200K	5300	60	12,000		15
59		22149-S	F096/841/ECO	Cool White	4100K	5900	82	15,000	94.00"	24	
		22173-S	F096/850/ECO	Super White	5000K	5900	80	15,000	94.00"	24	
Recessed (R17d)	75	25126-S	F60T12/CW/HO	Cool White	4200K	5200	60	12,000	60.00"	30	
		25120-S	F60T12/D/HO	Daylight	6500K	4600	76	12,000	60.00"	30	
		25128-S	F60T12/D35/HO	Neutral White	3500K	5600	70	12,000	57.72"	30	
		25119-S	F60T12/DSGN50/HO	Super White	5000K		90	12,000	60.00"	30	
Single Pin (Fa6)	75	29478-S	F96T12/CWX	Cool White	4100K	4400	87	12,000	96.00"	15	
		29500-S	F96T12/DX	Daylight	6500K	4360	88	12,000	96.00"	15	
Recessed (R17d)	80	25352-S	F64T12/CW/HO	Cool White	4200K	5750	60	12,000	64.00"	30	
		25353-S	F64T12/D/HO	Daylight	6500K	4900	76	12,000	64.00"	30	
		25355-S	F64T12/DSGN50/HO	Super White	5000K		90	12,000	64.00"	30	
	85	25176-S	F72T12/CW/HO	Cool White	4200K	6250	60	12,000	72.00"	15	
		25189-S	F72T12/D/HO	Daylight	6500K	5550	76	12,000	72.00"	15	
		25177-S	F72T12/WW/HO	Warm White	3000K	6400	52	12,000	72.00"	15	
	100	25384-S	F84T12/CW/HO	Cool White	4200K	7550	60	12,000	84.00"	15	
		25385-S	F84T12/D/HO	Daylight	6500K	6700	76	12,000	84.00"	15	
		25386-S	F84T12/DSGN50/HO	Super White	5000K		90	12,000	84.00"	15	
	110	25134-S	F96T12/CW/HO/COLD	Cool White	4200K	8600	60	12,000	96.00"	15	
		381764-P	F96T12/CW/HO-O	Cool White	4100K	7650	59	12,000	96.00"	15	
		25135-S	F96T12/D/HO/COLD	Daylight	6500K	7600	76	12,000	96.00"	15	
	160	25272-S	F72T12/CW/VHO	Cool White	4200K	10600	60	10,000	69.91"	15	

CATALOG \ 2019



END CAPS FOR TUBEGUARD

Item	Description	Color	Kelvin	Lumens	CRI	Hours	MOL	Pkg.	Features
05103-SU	END/T5	Black						24	■
05102-SU	END/T8	Black						24	■
05101-SU	END/T12	Black						24	■

T5 & T8 TUBEGUARD COVERS



	Item	Description	Color	Kelvin	Lumens	CRI	Hours	MOL	Pkg.	Features
T5	05112-SU	F28T5/TUBEGUARD/RB	Blue					48.00"	125	■
	05105-SU	F28T5TUBEGUARD	Clear					48.00"	125	
	05119-SU	F80T5/TUBEGUARD	Clear					57.00"	100	
T8	05196-SU	F25T8/TUBEGUARD	Clear					48.00"	48	
	05106-SU	F25T8/TUBEGUARD/B	Blue					48.00"	125	■
	05115-SU	F28T8/TUBEGUARD/G	Green					48.00"	125	■
	05122-SU	F32T8TUBEGUARD/A	Amber					48.00"	48	■
	05123-SU	F32T8TUBEGUARD/B	Blue					48.00"	24	■
	05124-SU	F32T8TUBEGUARD/G	Green					48.00"	24	■
	05125-SU	F32T8TUBEGUARD/P	Pink					48.00"	24	■
	05128-SU	F32T8/TUBEGUARD/PU	Purple					48.00"	24	■
	05126-SU	F32T8TUBEGUARD/R	Red					48.00"	48	■
	05190-SU	F32TUBEGUARD	Clear					48.00"	48	
	05127-SU	F40T8TUBEGUARD	Clear					60.00"	24	
	05194-SU	F96T8TUBEGUARD	Clear					96.00"	24	
	05120-SU	F032TUBEGUARD/UVA	UVA					48.00"	48	

T12 TUBEGUARD COVERS



	Item	Description	Color	Kelvin	Lumens	CRI	Hours	MOL	Pkg.	Features
	05111-SU	F30T12TUBEGUARD	Clear					36.00"	24	
	05186-SU	F40TUBEGUARD/A	Amber					48.00"	24	■
	05187-SU	F40TUBEGUARD/B	Blue					48.00"	24	■
	05188-SU	F40TUBEGUARD/G	Green					48.00"	24	■
	05192-SU	F40TUBEGUARD/MATRIX	Matrix					48.00"	24	
	05184-SU	F40T12/TUBEGUARD/PU	Purple					48.00"	24	■
	05191-SU	F40TUBEGUARD/R	Red					48.00"	24	■
	05185-SU	F40TUBEGUARD	Clear					48.00"	24	
	05157-SU	F96T12/TUBEGUARD/A	Amber					96.00"	24	■
	05152-SU	F96T12TUBEGUARD/G	Green					96.00"	24	■
	05156-SU	F96T12/TUBEGUARD/PK	Pink					96.00"	24	■
	05195-SU	F96T12TUBEGUARD	Clear					96.00"	24	

sunlite



INCANDESCENT



INCANDESCENT LAMPS

THE INCANDESCENT LAMP HAS NOT CHANGED MUCH SINCE THOMAS EDISON'S FIRST WORKING ELECTRIC LIGHT BULB WAS DESIGNED IN THE 1800S. THE FOLLOWING ARE SOME BASIC FACTS ABOUT INCANDESCENT LAMPS:

THE GLASS BULB

Oxygen, once it reaches the filament inside the lamp, will evaporate it immediately. It must therefore be encased in a glass bulb to protect it. Most incandescent lamps are either vacuum-sealed or gas-filled. Lamps filled with a mixture of argon and nitrogen creates a pressure against the filament and allows it to burn hotter and last longer.

THE FILAMENT

Incandescent lamp filaments are made of a metal called tungsten. Tungsten prevents early lamp failure since it can operate at very high temperatures without evaporating too quickly. These filaments only convert about 10% of the energy used into visible light so it is crucial that they are made from a material that can withstand extremely high temperatures. Coiled filaments, which have been found to be stronger and deliver better performance, are used today in most lamps.

HOW IT WORKS

The term incandescence means that when a metal is heated to very high temperatures, it begins to glow brightly. Therefore, when the tungsten filament of an incandescent lamp is heated through electricity, it will glow and produce light.

THE BASE

There are three parts that a screw base consists of:

1. The screw section
2. The glass insulation ring
3. The contact disc

The lead wires coming out of glass bulb are attached to the base at two points. One wire is soldered to the bottom of the contact disc and the other to the top edge of the screw section. The glass ring acts as an insulation barrier between the two points. Once the base is screwed into a socket and the contact disc touches the center point of the socket, the electric circuit is completed and the lamp can light up.

The base is attached with cement to the completely enclosed glass bulb. Most bases are made from aluminum or brass. Brass is more compatible with socket materials than aluminum and tends to perform somewhat better.

BULBBULB
BULBBULBBULB
BULBSHAPESBULB
BULBBULB

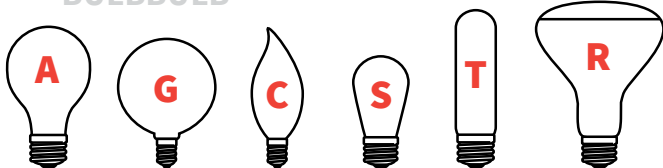

HOUSEHOLD GLOBE CHANDELIER SIGN TUBULAR REFLECTOR

The size and shape of a lamp's bulb are designated by a letter and a number. The letter specifies the shape of the bulb and the number indicates the maximum diameter in 1/8-inch increments. Example: A G40 is a globe shape which is 5 inches in diameter.

To the left are some basic shapes incandescent lamps are available in:

RATED VOLTAGE

The filament must be operated within a specific voltage range in order for it to deliver its intended light output. Incandescent lamps are made in both 120V and 130V versions.

The East Coast typically runs under voltage approximately 115V-120V, whereas, the Pacific Northwest typically runs at 120V-125V. This is especially true during the night when most of the city lights are shut off, the voltage tends to spike.

Lamps that are burned at voltages higher than their rating will result in higher wattage, efficacy (lumens per watt) and lumens. Lamps operated below their rated voltage will significantly increase their life while reducing their wattage, efficacy and lumen output.

Using 130V lamps, especially in outdoor fixtures, can increase the life of the bulb. 130V lamps are also known as heavy duty lamps.

HERE'S HOW IT WORKS:

A 130V 60W bulb produces 640 lumens and has a 2600 hour life.

A 120V 60W bulb produces 850 lumens and has a 1000 hour life.

As the voltage increases, the lumen output decreases and the hours of life increase.

If your voltage is running high (123V) the bulb burns a bit whiter (puts out more lumens) and the life of the bulb decreases. If you use a 130V bulb and are running at that same 123V, your bulb will burn a bit yellower (putting out fewer lumens) and the life of the bulb will increase.

BASE/CODES

MED or E - Medium	N - Intermediate
MOG - Mogul	MC - Mini Can
C - Candelabra	DC - Double Contact
E14 - European	SC - Single Contact

LUMEN MAINTENANCE

As the filament of the lamp burns out over time, 2 things happen:

1 The tungsten slowly evaporates and deposits itself on the interior wall of the bulb creating the black coating seen after a bulb has been in use for a while.

2 The lumen output decreases until it reaches the end of its life when the wire breaks.

It is recommended that a group replacement be done once a number of lamps have failed or a noticeable decrease in light output has taken place.

KRYPTON

Krypton bulbs create a bright white light, similar to halogen lamps. Unlike halogen lamps, however, which do not work well with dimmers, Krypton bulbs like standard incandescent ones work perfectly with light dimmers. Also, they last longer than standard incandescent bulbs, maintaining their lumen output for the full course of their life.

KRYPTON
PREMIUM LIGHT BULB
BRIGHTER, WHITER LIGHT

what is

NEOBRITE

These light bulbs contain Neodymium, a rare earth element that filters out the excessive yellow part of the spectrum to which our eyes are most sensitive. These incredible bulbs are the closest replication of natural sunlight available in an incandescent. These bulbs last up to five times longer than ordinary bulbs, show colors more accurately, increase the contrast between black and white, and reduce glare, eyestrain, and fatigue.

neobrite

what is

TUFF SKIN

These lamps are designed for any application where the bulbs are at risk of being broken. The rubber coating will contain the glass particles should the lamp break, keeping it from falling into food or anywhere else. Many jurisdictions now require the use of coated lamps in all food preparation, and service areas.

TUFF
skin

what is



A15 APPLIANCE

Base	Watts	Item	Description	Volts	Lumens	Finish	Hours	MOL	Pkg.	Features
Medium (E26)	15	02035-SU	15A15/CL	120	90	Clear	2,500	3.50"	24	
		02030-SU	15A15/FR	120	65	Frost	2,500	3.50"	24	
Intermediate (E17)	40	02056-SU	40A15/CL/N/CD2	120	320	Clear	2,500	3.45"	12	
Medium (E26)	40	02045-SU	40A15/CL	120	320	Clear	2,500	3.50"	12	
		02055-SU	40A15/CL/CD1	120	320	Clear	2,000	3.50"	12	
		02040-SU	40A15/FR 12PK	120	304	Frost	2,500	3.31"	12	
		02050-SU	40A15/FR/CD1	120	304	Frost	2,500	3.50"	12	
	60	02090-SU	60A15/CL/CD1	130	560	Clear	2,000	3.50"	12	
		02095-SU	60A15/FR/CD1	130	530	Frost	2,500	3.50"	12	



A19 HOUSEHOLD

Base	Watts	Item	Description	Volts	Lumens	Finish	Hours	MOL	Pkg.	Features
Medium (E26)	25	01043-SU	25A/FR	120	150	Frost	1,250	4.05"	24	
		01012-SU	40A/RS/3PK	120	300	Frost	2,000		40	
	40	01000-SU	40A/FR/2PK	130	350	Frost	1,250	4.05"	60	
		01004-SU	40A/RS	130	300	Frost	2,000		30	
	50	01083-SU	50A/RS/2PK	130	240	Frost	1,000	4.37"	120	
	60	00765-SU	60A/FR/220	220	580	Frost	1,250	4.05"	120	▲
	100	00775-SU	100A/FR/220	220	1100	Frost	1,250	4.05"	120	▲



A19 COLORED

Base	Watts	Item	Description	Volts	Lumens	Finish	Hours	MOL	Pkg.	Features
Medium (E26)	25	01135-SU	25A/B/2PK	120	-	Ceramic Blue	1,250	4.06"	12	■
		01160-SU	25A/O/2PK	120	-	Ceramic Orange	1,250	0.16"	12	■
		01120-SU	25A/R/2PK	120	-	Ceramic Red	1,250	4.16"	12	■
		01170-SU	25A/Y/2PK	120	-	Ceramic Yellow	1,250	0.16"	12	■
	40	01140-SU	40A/B/2PK	120	-	Ceramic Blue	1,250	4.05"	12	■
		01155-SU	40A/G/2PK	120	-	Ceramic Green	1,250	4.05"	12	■
		01165-SU	40A/O/2PK	120	-	Ceramic Orange	1,250	4.05"	12	■
		01125-SU	40A/R/2PK	120	-	Ceramic Red	1,250	4.05"	12	■
	60	01175-SU	40A/Y/2PK	120	-	Ceramic Yellow	1,250	4.05"	12	■
		01145-SU	60A/B/2PK	120	-	Ceramic Blue	1,250	4.06"	12	■
		01130-SU	60A/R/2PK	120	-	Ceramic Red	1,250	4.06"	12	■



A19 TRANSPARENT COLORED

Base	Watts	Item	Description	Volts	Lumens	Finish	Hours	MOL	Pkg.	Features
Medium (E26)	75	01096-SU	75A/BL	120	-	Ceramic Black Light	1,250	4.06"	25	■
	25	17000-SU	25A/TB/B/CD2	120	-	Transparent Blue	1,250	4.06"	6	■
		17005-SU	25A/TB/G/CD2	120	-	Transparent Green	1,250	4.06"	6	■
		17010-SU	25A/TB/R/CD2	120	-	Transparent Red	1,250	4.06"	6	■
		17015-SU	25A/TB/Y/CD2	120	-	Transparent Yellow	1,250	4.06"	12	■



A19 NEOBRITE HOUSEHOLD (Natural Light, Contains Neodymium)

Base	Watts	Item	Description	Volts	Lumens	Finish	Hours	MOL	Pkg.	Features
Medium (E26)	100	21005-SU	100A/NEO/FR/2PK	120	1180	Blue	2,000	4.17"	12	■
	150	21010-SU	150A/NEO/FR	120	1700	Blue	2,000	5.47"	12	■



A19 SILVERBOWL

Base	Watts	Item	Description	Volts	Lumens	Finish	Hours	MOL	Pkg.	Features
Medium (E26)	60	01217-SU	60A/SBIF	120	-	Frost	1,250	4.06"	24	
	100	01216-SU	100A/SB	120	-	Clear	1,250	4.06"	24	



A19 LEFT HAND THREAD

Base	Watts	Item	Description	Volts	Lumens	Finish	Hours	MOL	Pkg.	Features
Medium (E26)	100	01117-SU	100A/LHT/2PK	120	1150	Frost	1,250	4.02"	120	



A21

Base	Watts	Item	Description	Volts	Lumens	Finish	Hours	MOL	Pkg.	Features
Medium (E26)	150	01086-SU	150A/CL	120	1750	Clear	1,000	5.47"	48	



A21 3-WAY

Base	Watts	Item	Description	Volts	Lumens	Finish	Hours	MOL	Pkg.	Features
Medium (E26)	30-70-100	21050-SU	30/100	120	350-700-1,000	White	1,000	5.11"	12	
	50-100-150	21060-SU	50/150/3-WAY	120	550-1350-1950	White	1,250	4.90"	12	



ANTIQUÉ STYLE

Base	Watts	Item	Description	Volts	Lumens	Finish	Hours	MOL	Pkg.	Features
Medium (E26)	60	02038-SU	60A19/AQ/S/CL (60A19/CF)	120	-	Clear	2,000	4.20"	12	1
		02039-SU	60A19/AQ/L/SM	120	-	Smoke	3,000	4.33"	12	2
	40	02044-SU	40S19/AQ/T/GF	120	-	Golden Fleck	3,000	5.60"	12	3
		02041-SU	40S19/AQ/T/SM/3PK	120	-	Smoke	3,000	5.59"	8	4
	60	02043-SU	60S19/AQ/T/SM (60S19/CF)	120	-	Smoke	2,500	2.30"	12	4
Candelabra (E12)	40	02031-SU	40T8/AQ/T/SM/C	120	-	Smoke	3,000	3.54"	12	5
Medium (E26)	40	02052-SU	T10/AQ/40W/TF/A	120	140	Smoke	3,000	7.30"	12	6
		02053-SU	T10/AQ/40W/TF/A	120	140	Smoke	3,000	8.50"	12	6
		02059-SU	T10/AQ/40W/SF/A	120	140	Smoke	3,000	11.80"	12	6
		02036-SU	40T12/CF	120	-	Clear	2,000	4.00"	12	7
Candelabra (E12)	25	02046-SU	25CFC/AQ/S/SM/3PK	120	-	Smoke	3,000	4.40"	16	8
Medium (E26)	25	02047-SU	25EFC/AQ/S/SM/3PK	120	-	Smoke	3,000	4.40"	16	9
	60	02033-SU	60G25/AQ/T/SM	120	-	Smoke	3,000	4.56"	12	10
	40	02049-SU	40G40/AQ/T/SM	120	-	Smoke	3,000	6.61"	12	10



HIGH WATTAGE

Base	Watts	Item	Description	Volts	Lumens	Finish	Hours	MOL	Pkg.	Features
Medium (E26)	300	01068-SU	300PS/CL/3	130	3600	Clear	1,000	7.68"	24	
		01069-SU	300PS/FR/3	130	3420	Frost	1,000	7.68"	24	
Mogul (E39)	500	01078-SU	500PS/CL/MOG/3	130	6500	Clear	1,500	8.70"	24	
		01079-SU	500PS/FR	130	6175	Frost	1,000	8.70"	24	



PETITE CHANDELIER

Base	Watts	Item	Description	Volts	Lumens	Finish	Hours	MOL	Pkg.	Features
Candelabra (E12)	7	01322-SU	7CFC/25	120	39	Clear	2,500	2.90"	25	
	7.5	01321-SU	7CFF/25	120	37	Frost	2,500	2.90"	25	
	10	01324-SU	10CFC/25	120	55	Clear	2,500	3.15"	25	
		01323-SU	10CFF/25	120	55	Frost	2,500	3.15"	25	
	25	01491-SU	25CFC/25	120	194	Clear	1,500	3.50"	25	
	40	01492-SU	40CFC/25	120	388	Clear	1,500	3.50"	25	



PETITE CHANDELIER (CONTINUED)

Base	Watts	Item	Description	Volts	Lumens	Finish	Hours	MOL	Pkg.	Features
Candelabra (E12)	15	01330-SU	15CFF/25	120	95	Frost	1,500	3.75"	25	
		01332-SU	15CFF/25/CD2	120	95	Frost	1,500	3.50"	24	
		01364-SU	15CFF/25/3	130	90	Frost	1,500	3.75"	25	
		01365-SU	15CTC/25	120	90	Clear	2,000	3.50"	25	
		01370-SU	15CTF/25	120	70	Frost	2,000	3.20"	25	
		01372-SU	15CTF/25/3	130	70	Frost	1,500	3.20"	25	
	25	01272-SU	25CTC/25	120	180	Clear	1,500	3.50"	25	

FLAME TIP CHANDELIER



Base	Watts	Item	Description	Volts	Lumens	Finish	Hours	MOL	Pkg.	Features
Candelabra (E12)	15	01328-SU	15CFC/32			Clear	1,500		25	
	25	01335-SU	25CFC/32	120	194	Clear	1,500	3.75"	25	
		01510-SU	25CFC/32/CD2	120	194	Clear	1,500	3.75"	24	
		01340-SU	25CFF/32	120	178	Frost	1,500	4.00"	25	
		01513-SU	25CFF/32/CD2	120	178	Frost	1,500	3.75"	24	
	40	01345-SU	40CFC/32	120	388	Clear	1,500	3.75"	25	
		01515-SU	40CFC/32/CD2	120	370	Clear	1,500	3.75"	24	
		01350-SU	40CFF/32	120	360	Frost	1,500	3.77"	25	
	60	01355-SU	60CFC/32	120	540	Clear	2,000	3.75"	25	
		01525-SU	60CFC/32/CD2	120	540	Clear	2,000	3.75"	24	
		01360-SU	60CFF/32	120	540	Frost	2,000	3.75"	25	
		01521-SU	60CFF/32/CD2	120	580	Frost	2,000	3.75"	24	
	Medium (E26)	25	01405-SU	25EFC/32	120	194	Clear	1,500	4.00"	25
01408-SU			25EFC/32/3	130	194	Clear	1,500	4.02"	25	
01549-SU			25EFC/32/CD2	120	194	Clear	1,500	4.00"	24	
01410-SU			25EFF/32	120	178	Frost	1,500	4.00"	25	
01412-SU			25EFF/32/3	130	186	Frost	1,500	3.93"	25	
01543-SU			25EFF/32/CD2	120	178	Frost	1,500	4.00"	24	
40		01415-SU	40EFC/32	120	388	Clear	1,500	4.00"	25	
		01418-SU	40EFC/32/3	130	388	Clear	1,500	4.00"	25	
		01550-SU	40EFC/32/CD2	120	388	Clear	1,500	4.00"	24	
		01545-SU	40EFF/32/CD2	120	360	Frost	1,500	4.00"	24	

PHONE / 718.768.7000

FAX / 718.768.0970

WWW.SUNLITE.COM

TORPEDO TIP CHANDELIER



Base	Watts	Item	Description	Volts	Lumens	Finish	Hours	MOL	Pkg.	Features
Candelabra (E12)	25	01375-SU	25CTC/32	120	175	Clear	1,500	3.77"	25	
		01378-SU	25CTC/32/3	130	162	Clear	1,500	3.75"	25	
		01530-SU	25CTC/32/CD2	120	162	Clear	1,500	3.75"	24	
		01257-SU	25CTC/HV	220	180	Clear	1,500	3.75"	25	▲
		01380-SU	25CTF/32	120	178	Frost	1,500	3.75"	25	
		01374-SU	25CTF/32/3	130	150	Frost	1,500	3.75"	25	
		01342-SU	25CTW/32	120	140	White	1,500	3.75"	25	
	40	01385-SU	40CTC/32	120	388	Clear	1,500	3.78"	25	
		01383-SU	40CTC/32/3	130	388	Clear	1,500	3.55"	25	
		01535-SU	40CTC/32/CD2	120	328	Clear	1,500	3.75"	24	
		01262-SU	40CTC/HV	220	380	Clear	1,500	3.75"	25	▲
		01390-SU	40CTF/32	120	360	Frost	1,500	3.75"	25	
		01512-SU	40CTF/32/CD2	120	305	Frost	1,500	3.75"	24	
		01352-SU	40CTW/32	120	300	White	1,500	3.75"	25	
Candelabra (E12)	60	01395-SU	60CTC/32	120	592	Clear	1,500	3.71"	25	
		01393-SU	60CTC/32/3	130	560	Clear	1,500	3.75"	25	
		01523-SU	60CTC/32/CD2	120	560	Clear	2,000	3.75"	24	
		01267-SU	60CTC/32/HV	220	550	Clear	1,500	3.75"	25	▲
		01400-SU	60CTF/32	120	540	Frost	1,500	3.75"	25	
		01398-SU	60CTF/32/3	130	540	Frost	1,500	3.75"	25	
		01544-SU	60CTF/32/CD2	120	530	Frost	1,500	3.75"	24	
		01362-SU	60CTW/32	120	480	White	1,500	3.75"	25	

TORPEDO TIP CHANDELIER



Base	Watts	Item	Description	Volts	Lumens	Finish	Hours	MOL	Pkg.	Features
Medium (E26)	25	01435-SU	25ETC/32	120	194	Clear	1,500	4.00"	25	
		01438-SU	25ETC/32/3	130	194	Clear	1,500	4.00"	25	
		01560-SU	25ETC/32/CD2	120	162	Clear	1,500	4.00"	24	
		01565-SU	25ETF/32/CD2	120	150	Frost	1,500	4.00"	24	
	40	01445-SU	40ETC/32	120	388	Clear	1,500	4.00"	25	
		01450-SU	40ETF/32	120	360	Frost	1,500	4.00"	25	
		01422-SU	40ETW/32	120	300	White	1,500	4.00"	25	
60	01432-SU	60ETW/32	120	480	White	1,500	4.00"	25		
Intermediate (E14)	25	01465-SU	25CTC/32/E14	120	180	Clear	1500	3.95"	25	
		01470-SU	25CTF/32/E14	120	160	Frost	1500	3.95"	25	
	40	01475-SU	40CTC/32/E14	120	350	Clear	1500	3.95"	25	
		01480-SU	40CTF/32/E14	120	320	Frost	1500	3.95"	25	
	60	01485-SU	60CTC/32/E14	120	550	Clear	1500	3.75"	25	
		01490-SU	60CTF/E32/E14	120	520	Frost	1500	3.95"	25	
		01487-SU	60CTC/E14HV	220	550	Clear	-	-	25	▲



CHANDELIER FLICKER

Base	Watts	Item	Description	Volts	Lumens	Finish	Hours	MOL	Pkg.	Features
Candelabra (E12)	3	01506-SU	3CFC/P/ 12PK	120		Clear	1500	2.80"	20	
		01500-SU	3CFC	120		Clear	1,500	4.12"	25	
		01495-SU	3CTC	120		Clear	1,500	3.56"	25	
Medium (E26)	3	01504-SU	3EFC	120		Clear	1,500	3.96"	25	
		01505-SU	3ETC	120		Clear	1,500	3.59"	25	

KRYPTON CHANDELIER



Base	Watts	Item	Description	Volts	Lumens	Finish	Hours	MOL	Pkg.	Features
Candelabra (E12)	25	02815-SU	K25CFC	120	200	Clear	3,000	4.00"	25	
		02800-SU	K25CTC	120	200	Clear	3,000	3.75"	25	
	40	02820-SU	K40CFC	120	380	Clear	3,000	3.81"	25	
		02805-SU	K40CTC	120	380	Clear	3,000	3.75"	25	
	60	02825-SU	K60CFC	120	560	Clear	3,000	4.00"	25	
		02810-SU	K60CTC	120	580	Clear	3,000	3.75"	25	
Medium (E26)	40	02835-SU	K40ETC	120	380	Clear	3,000	3.65"	25	
	60	02840-SU	K60ETC	120	580	Clear	3,000	3.65"	25	

FLAME TWIST



Base	Watts	Item	Description	Volts	Lumens	Finish	Hours	MOL	Pkg.	Features
Medium (E26)	25	33010-SU	25FM/W/ CD2	120	150	White	2,000	4.37"	6	
	60	34060-SU	60FM/W/ CD2	120	500	White	2,000	4.37"	6	

PRISMLITE



Base	Watts	Item	Description	Volts	Lumens	Finish	Hours	MOL	Pkg.	Features
Candelabra (E12)	25	34300-SU	25P/AU/ CD2	120	180	Auradescent	2,000	4.45"	6	
	40	34350-SU	40P/CL/ CD2	120	350	Clear	2,000	4.45"	6	
		34400-SU	40P/FR/ CD2	120	320	Frost	2,000	4.45"	6	

G11 GLOBE



Base	Watts	Item	Description	Volts	Lumens	Finish	Hours	MOL	Pkg.	Features
Candelabra (E12)	10	01610-SU	10G11/CL	120	65	Clear	1,500	2.25"	25	
		01615-SU	10G11/WH	120	56	White	1,500	2.25"	25	



G16 GLOBE

Base	Watts	Item	Description	Volts	Lumens	Finish	Hours	MOL	Pkg.	Features
Medium (E26)	25	01690-SU	25G16/CL/MED	120	180	Clear	2,000	2.75"	25	
		01695-SU	25G16/WH/MED	120	150	White	2,000	2.75"	25	
	40	01700-SU	40G16/CL/MED	120	350	Clear	2,000	2.75"	25	
		01705-SU	40G16/WH/MED	120	298	White	2,000	2.80"	25	



G16.5 GLOBE

Base	Watts	Item	Description	Volts	Lumens	Finish	Hours	MOL	Pkg.	Features
Candelabra (E12)	15	01640-SU	15G16.5/CL	120	105	Clear	1,500	2.85"	25	
		01645-SU	15G16.5/WH	120	84	White	1,500	2.85"	25	
	25	01650-SU	25G16.5/CL	120	180	Clear	1,500	2.75"	25	
		01665-SU	25G16.5/WH	120	150	White	1,500	2.85"	25	
	40	01613-SU	25G16.5/WH/3	130	140	White	2,000	2.85"	25	
		01670-SU	40G16.5/CL	120	350	Clear	1,500	2.85"	25	
		01583-SU	40G16.5/CL/CD2	120	350	Clear	1,500	2.85"	24	
		01675-SU	40G16.5/WH	120	298	White	1,500	2.85"	25	
	60	01680-SU	60G16.5/CL	120	540	Clear	1,500	2.85"	25	
		01685-SU	60G16.5/WH	120	450	White	1,500	2.85"	25	
		01628-SU	60G16.5/WH/3	130	420	White	1,500	2.85"	25	
	25	01203-SU	25G16.5/SB	120	-	Clear	1,500	2.85"	25	
40	01248-SU	40G16.5/SB	120	-	Clear	1,500	2.85"	25		

G19 GLOBE



Base	Watts	Item	Description	Volts	Lumens	Finish	Hours	MOL	Pkg.	Features
Medium (E26)	25	08250-SU	25G19/CL	120	170	Clear	2,000	3.20"	25	

G25 GLOBE



Base	Watts	Item	Description	Volts	Lumens	Finish	Hours	MOL	Pkg.	Features
Medium (E26)	25	01720-SU	25G25/CL	120	180	Clear	2,000	4.50"	24	
		01722-SU	25G25/CL/3	130	180	Clear	2,500	4.50"	24	
		01725-SU	25G25/WH	120	150	White	2,000	4.50"	24	
		01727-SU	25G25/WH/3	130	150	White	2,000	4.50"	24	
	40	01730-SU	40G25/CL	120	320	Clear	2,000	4.50"	24	
		01732-SU	40G25/CL/3	130	320	Clear	2,000	4.50"	24	
		01735-SU	40G25/WH	120	330	White	2,000	4.50"	24	
		01738-SU	40G25/WH/3	130	300	White	2,500	4.50"	24	
		01253-SU	40G25/SB	120	-	Silverbowl	2,000	4.50"	24	
		60	01277-SU	60G25/SB	120	-	Silverbowl	2,000	4.50"	24



G40 GLOBE & SILVERBOWL

Base	Watts	Item	Description	Volts	Lumens	Finish	Hours	MOL	Pkg.	Features
Medium (E26)	25	01760-SU	25G40/CL	120	160	Clear	2,000	6.82"	24	
		01765-SU	25G40/WH	120	128	White	2,000	6.36"	24	
	40	01770-SU	40G40/CL	120	360	Clear	2,000	6.36"	24	
	60	01785-SU	60G40/WH	120	498	White	2,000	6.65"	24	
	100	01795-SU	100G40/WH	120	760	White	2,000	6.36"	24	
	60	01283-SU	60G40/SB	120	-	Silverbowl	2,000	6.36"	24	

S11 INDICATOR



Base	Watts	Item	Description	Volts	Lumens	Finish	Hours	MOL	Pkg.	Features
Medium (E26)	7.5	01245-SU	7.5S11/CL	120	35	Clear	2,000	2.12"	25	
		01585-SU	7.5S11/CL/CD1	120	35	Clear	2,000	2.12"	12	
		01250-SU	7.5S11/WH	120	20	White	2,000	2.12"	25	
		01590-SU	7.5S11/WH/CD1	120	20	White	2,000	2.12"	12	
		01220-SU	7.5S11/B	120	-	Ceramic Blue	2,000	2.12"	25	■
		01225-SU	7.5S11/G	120	-	Ceramic Green	2,000	2.12"	25	■
		01235-SU	7.5S11/O	120	-	Ceramic Orange	2,000	2.12"	25	■
		01240-SU	7.5S11/R	120	-	Ceramic Red	2,000	2.12"	25	■
		01230-SU	7.5S11/Y	120	-	Ceramic Yellow	2,000	2.12"	25	■

S11 HIGH INTENSITY



Base	Watts	Item	Description	Volts	Lumens	Finish	Hours	MOL	Pkg.	Features
Intermediate (E17)	40	01608-SU	40S11/N/CL	120	300	Clear	2,000	2.27"	25	
	10	01601-SU	10S11/CL/N/3	130	55	Clear	2,000	2.33"	25	
	40	01605-SU	40S11/N/CL	120	300	Clear	2,000	2.27"	24	

S14 SIGN



Base	Watts	Item	Description	Volts	Lumens	Finish	Hours	MOL	Pkg.	Features
Medium (E26)	11	01214-SU	11S14/C/3/2PK	130	80	Clear	2,000	3.38"	12	
		01210-SU	11S14/CL/2PK	120	80	Clear	2,000	3.38"	24	
		01212-SU	11S14/FR	120	80	Frost	2,000	3.38"	24	



S14 SIGN

Base	Watts	Item	Description	Volts	Lumens	Finish	Hours	MOL	Pkg.	Features
Medium (E26)	11	01190-SU	11S14/G	120		Ceramic Green	2,000	3.38"	24	■
		01200-SU	11S14/O	120		Ceramic Orange	2,000	3.38"	24	■
		01205-SU	11S14/R/4PK	120		Ceramic Red	2,000	3.38"	24	■
		01195-SU	11S14/Y/2PK	120		Ceramic Yellow	2,000	3.38"	24	■
		01187-SU	11S14/TB/4PK	120		Transparent Blue	2,000	3.38"	24	■
		01194-SU	11S14/TG/4PK	120		Transparent Green	2,000	3.38"	24	■
		01202-SU	11S14/TO	120		Transparent Orange	2,000	3.38"	24	■
		01208-SU	11S14/TR/2PK	120		Transparent Red	2,000	3.38"	24	■
		01178-SU	11S14/TY/3/4PK	130		Transparent Yellow	2,000	3.12"	24	■



C7 NIGHT LIGHT

Base	Watts	Item	Description	Volts	Lumens	Finish	Hours	MOL	Pkg.	Features
Candelabra (E12)	7	01255-SU	7C7/B/25PK	120	-	Blue	2,000	2.09"	20	■
		01222-SU	7C7/B/CD4	120	-	Blue	2,000	2.09"	24	■
		01260-SU	7C7/G/25PK	120	-	Ceramic Green	2,000	2.09"	20	■
		01227-SU	7C7/G/CD4	120	-	Ceramic Green	2,000	2.09"	24	■
		01270-SU	7C7/O/25PK	120	-	Ceramic Orange	2,000	2.09"	20	■
		01232-SU	7C7/O/CD4	120	-	Ceramic Orange	2,000	2.09"	24	■
		01275-SU	7C7/R/25PK	120	-	Ceramic Red	2,000	2.09"	20	■
		01237-SU	7C7/R/CD4	120	-	Ceramic Red	2,000	2.09"	24	■
		01265-SU	7C7/Y/25PK	120	-	Yellow	2,000	2.09"	20	■
	01242-SU	7C7/Y/CD4	120	-	Yellow	2,000	2.09"	24	■	
	4	01630-SU	4C7/CL/25PK	120	18	Clear	2,000	2.09"	25	
		01632-SU	4C7/CL/CD2	120	18	Clear	2,000	2.09"	12	
		01634-SU	4C7/WH/25PK	120	15	White	2,000	2.09"	25	
		01638-SU	4C7/WH/CD2	120	15	White	2,000	2.09"	12	
	7	01280-SU	7C7/CL/25PK	120	30	Clear	2,000	2.09"	20	
		01595-SU	7C7/CL/CD2	120	30	Clear	2,000	2.10"	12	
		01591-SU	7C7/CL/CD4	120	30	Clear	2,000	2.09"	24	
		01285-SU	7C7/WH/25PK	120	30	White	2,000	0.08"	20	
		01600-SU	7C7/WH/CD2	120	25	White	2,000	2.09"	12	
10	01592-SU	7C7/WH/CD4	120	25	White	2,000	2.09"	24		
	01620-SU	10C7/CL/25PK	120	35	Clear	2,000	2.09"	25		
Double Contact Bayonet (BA15d)	10	01622-SU	10C7/CL/DC	120	35	Clear	2,000	2.09"	25	



S6

Base	Watts	Item	Description	Volts	Lumens	Finish	Hours	MOL	Pkg.	Features
Candelabra (E12)	6	01320-SU	6S6/CL/C	120	40	Clear	2,000	1.78"	12	



C9 NIGHT LIGHT

Base	Watts	Item	Description	Volts	Lumens	Finish	Hours	MOL	Pkg.	Features
Intermediate (E17)	7	01290-SU	7C9/B	120	-	Ceramic Blue	2,000	2.86"	20	■
		01295-SU	7C9/G	120	-	Ceramic Green	2,000	2.86"	20	■
		01305-SU	7C9/O	120	-	Ceramic Orange	2,000	2.86"	20	■
		01310-SU	7C9/R	120	-	Ceramic Red	2,000	2.86"	20	■
		01313-SU	7C9/TB	120	-	Transparent Blue	2,000	2.86"	20	■
		01314-SU	7C9/TG	120	-	Transparent Green	2,000	2.86"	20	■
		01311-SU	7C9/TR	120	-	Transparent Red	2,000	2.86"	20	■
		01312-SU	7C9/TY	120	-	Transparent Yellow	2,000	2.86"	20	■
		01315-SU	7C9/CL	120	30	Clear	2,000	2.94"	20	
		01303-SU	7C9/WH	120	25	White	1500	2.86"	20	

R14 REFLECTOR



Base	Watts	Item	Description	Volts	Lumens	Finish	Hours	MOL	Pkg.	Features
Intermediate (E17)	25	01820-SU	25R14/FL/N	120	170	Clear	1500	2.50"	25	
	40	01800-SU	40R14/FL/N	120	325	Clear	1500	2.56"	25	
Medium (E26)	25	01825-SU	25R14/FL	120	170	Frost	1,500	2.12"	25	
	40	01805-SU	40R14/FL	120	325	Clear	1,500	2.09"	25	

R16 REFLECTOR



Base	Watts	Item	Description	Volts	Lumens	Finish	Hours	MOL	Pkg.	Features
Medium (E26)	40	01815-SU	40R16/FL	120	325	Clear	1,500	3.38"	25	

R20, R20 COLORED REFLECTOR



Base	Watts	Item	Description	Volts	Lumens	Finish	Hours	MOL	Pkg.	Features
Medium (E26)	30	01830-SU	30R20/FL	120	260	Clear	2,000	4.00"	25	
	45	01834-SU	45R20/FL	120	320	Frost	2,000	3.91"	25	
		01833-SU	45R20/FL/3	130	320	Clear	2,000	4.00"	25	
	50	01836-SU	50R20/FL/A	120	-	Amber	2,000	4.00"	12	■
		01843-SU	50R20/FL/G	120	-	Green	2,000	4.00"	12	■
		01848-SU	50R20/FL/O	120	-	Orange	2,000	4.00"	12	■
		01858-SU	50R20/FL/Y	120	-	Yellow	2,000	4.00"	12	■



R40 HEAT LAMP

Base	Watts	Item	Description	Volts	Lumens	Finish	Hours	MOL	Pkg.	Features
Medium (E26)	125	03687-SU	125R40/H/CL Heat Lamp	125	-	Clear	2,000	6.75"	12	
		03690-SU	250R40/H/CL Heat Lamp	125	-	Clear	2,000	6.75"	12	
	250	02062-SU	250R40/CL/TS	125	-	Clear/Tuff Skin	1,500	6.75"	12	
		03685-SU	250R40/H/R Heat Lamp	125	-	Transparent Red	2,000	6.75"	12	■
		02063-SU	250R40/RED/TS	130	-	Transparent Red/Tuff Skin	1,500	6.75"	12	■
	375	03697-SU	375R40/H/CL Heat Lamp	125	-	Clear	3,000	6.75"	12	
		03689-SU	375R40/H/R Heat Lamp	125	-	Red	2,000	6.75"	12	■
		03683-SU	375R40/RED/TS	120	-	Red/Tuff Skin	2,000	6.75"	12	■



BR30 NEOBRITE | COLORED REFLECTOR

Base	Watts	Item	Description	Volts	Lumens	Finish	Hours	MOL	Pkg.	Features
Medium (E26)	50	01866-SU	50BR30/FL/3	130	550	Clear	4,000	5.00"	24	
		01863-SU	65BR30/FL/3	130	450	Clear	2,000	5.00"	24	
		01893-SU	65BR30/G	120	-	Green	2,000	5.00"	12	■
		21020-SU	65BR30/NeoBrite Contains Neodymium	120	-	Frost	2,000	5.00"	24	



BR38 COLORED REFLECTOR

Base	Watts	Item	Description	Volts	Lumens	Finish	Hours	MOL	Pkg.	Features
Medium (E26)	100	01868-SU	100BR38/FL/B	120	-	Prismatic Blue	2,000	5.75"	12	■
		01873-SU	100BR38/FL/G	120	-	Prismatic Green	2,000	5.75"	12	■
		01878-SU	100BR38/FL/R	120	-	Prismatic Red	2,000	5.75"	12	■
		01883-SU	100BR38/FL/Y	120	-	Prismatic Yellow	2,000	5.75"	12	■



BR40 REFLECTOR

Base	Watts	Item	Description	Volts	Lumens	Finish	Hours	MOL	Pkg.	Features
Medium (E26)	65	01819-SU	65BR40/FL/3	130	550	Frost	2,000	6.25"	24	
Mogul (E39)	300	01065-SU	300R40/FL/MOG/3	130	2400	Clear	4,000	7.25"	24	



PRE

Base	Watts	Item	Description	Volts	Lumens	Finish	Hours	MOL	Pkg.	Features
Intermediate (E14)	15	02150-SU	15WPR/E14	120	80	Clear	2,000	2.35"	25	
	25	02160-SU	25WPRE14	120	180	Clear	2,000	2.35"	25	



ELEVATOR

Base	Watts	Item	Description	Volts	Lumens	Finish	Hours	MOL	Pkg.	Features
Single Contact Bayonet (BA15s)	20	07395-SU	1383	13	600	Frost	1,000	2.56"	10	

T4 & T5 TUBULAR



Base	Watts	Item	Description	Volts	Lumens	Finish	Hours	MOL	Pkg.	Features
Candelabra (E12)	15	02085-SU	15T4/CL/10PK	120	75	Clear	2,000	1.50"	10	
Intermediate (E14)	10	01902-SU	10T5.5/E14/3/10PK	130	50	Clear	1,000	2.00"	10	

T6 TUBULAR



Base	Watts	Item	Description	Volts	Lumens	Finish	Hours	MOL	Pkg.	Features
Candelabra (E12)	15	01900-SU	15T6/CL	120	90	Clear	2,000	3.06"	25	
		01905-SU	15T6/CL/145V	145	80	Clear	2,000	3.06"	25	
		01901-SU	15T6/CL/3	130	90	Clear	2,000	3.06"	25	
	25	01910-SU	25T6/CL/C	120	180	Clear	2,000	3.06"	25	
Double Contact Bayonet (BA15d)	15	01908-SU	15T6/CL/DC	120	90	Clear	2,000	3.00"	25	

PHONE / 718.768.7000

FAX / 718.768.0970

WWW.SUNLITE.COM



T6.5 TUBULAR

Base	Watts	Item	Description	Volts	Lumens	Finish	Hours	MOL	Pkg.	Features
Double Contact Bayonet (BA15d)	20	01940-SU	20T6.5/DC/CL	120	90	Clear	5,000	5.25"	25	
		01945-SU	20T6.5/FR/DC	120	90	Frost	5,000	5.25"	25	
		01960-SU	25T6.5/CL/DC/3	130	220	Clear	1,000	5.25"	25	
	25	01957-SU	25T6.5/DC/CL/CD1	120	170	Clear	2,000	5.25"	24	
		01965-SU	25T6.5/FR/DC	120	170	Frost	5,000	5.25"	25	
		01980-SU	40T6.5/CL/DC	130	290	Clear	5,000	5.25"	25	
40	01985-SU	40T6.5/FR/DC	120	290	Frost	5,000	5.25"	25		
	Intermediate (E17)	20	01950-SU	20T6.5/CL/N/3	130	90	Clear	5,000	5.25"	25
01955-SU			20T6.5/FR/N	120	90	Frost	5,000	5.25"	25	
25		01970-SU	25T6.5/CL/N	120	120	Clear	5,000	5.25"	25	
		01967-SU	25T6.5/CL/N/CD1	120	170	Clear	5,000	5.25"	24	
40		01990-SU	40T6.5/CL/N	120	290	Clear	5,000	5.25"	25	
		01995-SU	40T6.5/FR/N	120	290	Frost	5,000	5.25"	25	



T7 TUBULAR

Base	Watts	Item	Description	Volts	Lumens	Finish	Hours	MOL	Pkg.	Features
Candelabra (E12)		01915-SU	15T7/C	120	90	Clear	2,000	2.15"	25	
Double Contact Bayonet (BA15d)	15	01925-SU	15T7/CL/DC	120	90	Clear	2,000	2.22"	25	
Intermediate (E17)		01920-SU	15T7/CL/N	120	90	Clear	2,000	2.24"	25	
Candelabra (E12)	25	01928-SU	25T8/CL/C	120	180	Clear	2,000	2.50"	25	



T8 TUBULAR

Base	Watts	Item	Description	Volts	Lumens	Finish	Hours	MOL	Pkg.	Features
Double Contact Bayonet (BA15d)	25	01935-SU	25T8/CL/DC	120	180	Clear	2,000	2.50"	25	
Intermediate (E17)	25	01930-SU	25T8/CL/N	120	180	Clear	2,000	2.50"	25	
	40	01987-SU	40T8/CL/N	120	180	Clear	2,000	2.50"	25	

T8 TUBULAR SHOWCASE



Base	Watts	Item	Description	Volts	Lumens	Finish	Hours	MOL	Pkg.	Features
Medium (E26)	40	01996-SU	40T8/CL	120	230	Clear	2,000	12.00"	25	
		01997-SU	40T8/FR	120	210	Frost	2,000	12.00"	25	
	75	01998-SU	75T8/CL	120	450	Clear	2,000	12.00"	25	
		01999-SU	75T8/FR	120	875	Frost	2,000	12.00"	25	

T10 TUBULAR SHOWCASE



Base	Watts	Item	Description	Volts	Lumens	Finish	Hours	MOL	Pkg.	Features
Medium (E26)	25	02000-SU	25T10/CL	120	160	Clear	2,000	5.00"	25	
		02006-SU	25T10/CL/CD1	120	160	Clear	2,000	5.00"	24	
		02005-SU	25T10/FR	120	140	Frost	2,000	5.00"	25	
		02007-SU	25T10/FR/CD1	120	140	Frost	2,000	5.00"	24	
	40	02010-SU	40T10/CL	120	260	Clear	2,000	4.85"	25	
		02016-SU	40T10/CL/CD1	120	260	Clear	2,000	5.00"	24	
		02015-SU	40T10/FR	120	240	Frost	2,000	5.00"	25	
		02017-SU	40T10/FR/CD1	120	240	Frost	2,000	5.00"	24	
	60	02080-SU	40T10/BL/CD1	120	-	Black Light	2,000	0.19"	24	■
		02020-SU	60T10/CL	120	360	Clear	2,000	5.00"	25	
		02025-SU	60T10/FR	120	360	Frost	2,000	5.00"	25	

PHONE / 718.768.7000

FAX / 718.768.0970

WWW.SUNLITE.COM

sunlite



HALOGEN



HALOGEN LAMPS

HALOGEN LIGHT BULBS WORK ALMOST EXACTLY LIKE INCANDESCENT LAMPS BY HEATING THE TUNGSTEN FILAMENT UNTIL IT GLOWS. HALOGENS HOWEVER, IMPROVE ON THE PROCESS. HERE'S HOW:



HOW IT WORKS

The operation of halogen lamps is based on the "Halogen Cycle". The temperature at which a halogen lamp operates is a significant factor for the halogen cycle to work properly. The interior wall of the bulb must be above 250° C and less than 1,100° C. The filament of the lamp must reach at least 2,000° C. In order for the filament to reach this high temperature, the glass bulb, or envelope, must encompass it as closely as possible.



HALOGEN LAMPS OFFER A MANY OF BENEFITS THAT MAKE THEM A GREAT ALTERNATIVE TO INCANDESCENT BULBS:

BRILLIANT, WHITE LIGHT

Halogen lamps deliver a crisp, white light. Because halogen lamps are so similar to incandescents, they render colors as accurately, only better. The quantity of the light is greater and creates a higher contrast than a standard incandescent of comparable wattage. They offer superior lumen performance throughout the life of the lamp. This makes them perfect for reading, display, accent and general lighting.

LONG LIFE

Standard incandescent lamps and halogen lamps both use tungsten filaments. The filament in an incandescent lamp, however, evaporates over time, causing it to weaken and eventually break. When the tungsten inside a halogen lamp evaporates, the gasses inside causes it to be redeposited back into the filament. This cycle continues for a lamp life of 2,000 hours or more.

DIMMING

Although standard incandescents benefit from being used with a dimmer due to the reduced voltage being applied to the filament, dimming a halogen lamp can actually be harmful to it and reduce its light output and life.

Here's why: In order for the halogen cycle to work properly, halogen lamp filaments need to be operated at 250° C or higher. When used with a dimmer, the filament will not reach this temperature and detract from its proper function. Halogen lamps that are dimmed to low levels for extended periods of time will begin to blacken on the inside wall of the bulb since the tungsten, which needs to make its way back to the filament can no longer do so at the same rate while operating at a lower temperature. Since the filament deteriorates much faster, lamp life and light output are then reduced. It is possible, though, to restore the bulb to a certain degree of its original state by running the lamp non-dimmed every so often. Watch as the halogen cycle actually cleans the inside of the bulb.



Standard incandescent lamps can be handled with bare hands. However, the envelope (also known as bulb) of a halogen lamp reaches such high temperatures that when it is handled the oils and salt from our skin that remains on the glass envelope cause the lamp to weaken and can quickly lower the lamp's light output and significantly shorten its life.

If your hands should come in contact with the bulb, use a small amount of rubbing alcohol and a soft cloth to clean the lamp, allow time for the bulb to dry before using.

BEAMSPREAD CODES

- NSP** Narrow Spot
- SP** Spot
- NFL** Narrow Flood
- FL** Flood
- WFL** Wide Flood

BEAM-SPREAD

DIAMETERS (ACTUAL SIZES)

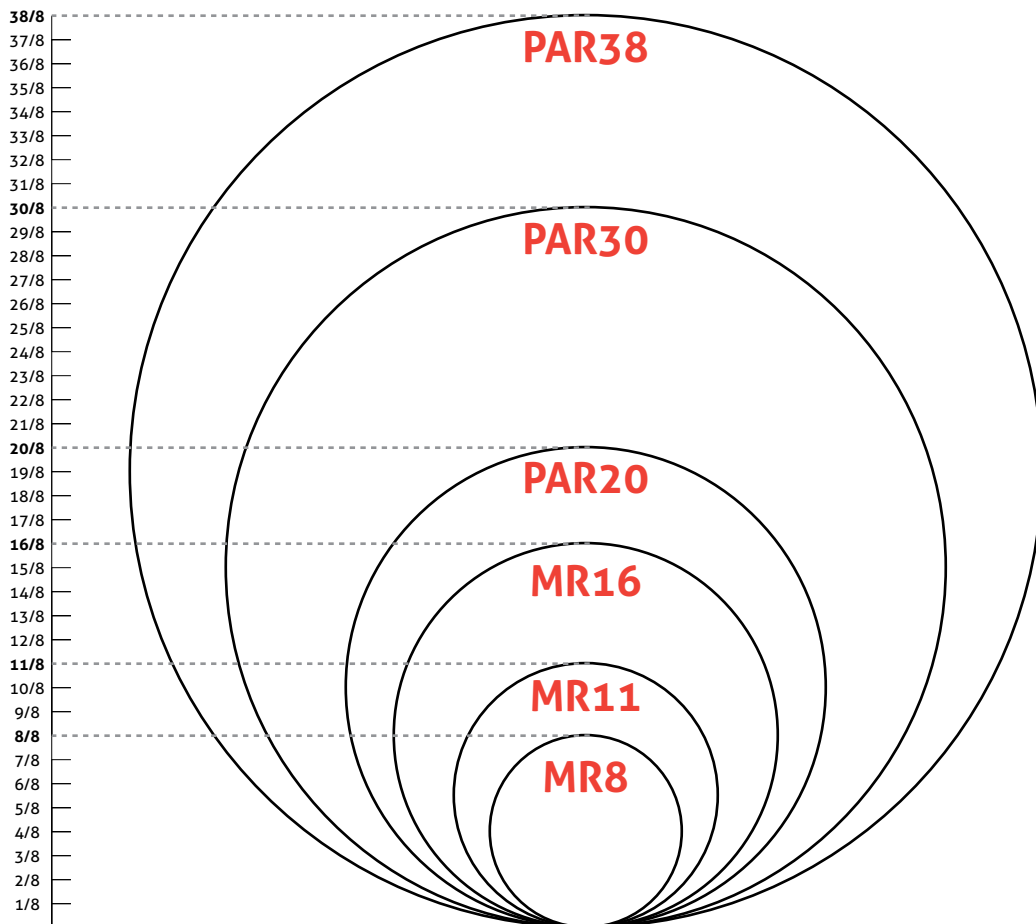

NSP 10° MR16

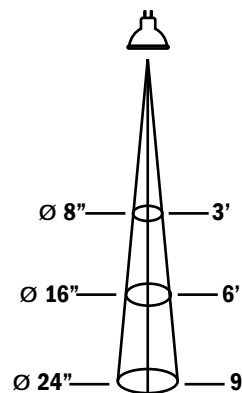

FL 38° MR16

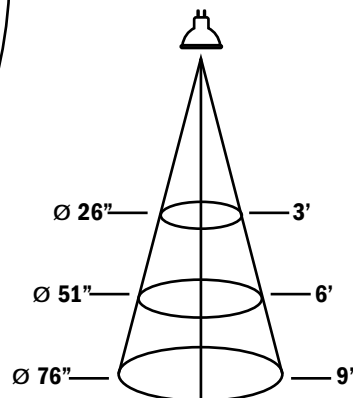



JDD DOUBLE ENVELOPE T10

Base	Watts	Item	Description	ASNI	Lumens	Volts	Finish	Hours	MOL	Pkg.	Features
Medium (E26)	150	03043-SU	150T10/HAL/CL	JDD	2050	230	Clear	2,000	4.33"	12	▲



SINGLE ENDED T4 | MINI CAN

Base	Watts	Item	Description	ASNI	Lumens	Volts	Finish	Hours	MOL	Pkg.	Features
Mini Can (E11)	50	03081-SU	Q50/FR/MC		600	120	Frost	2,000	2.40"	12	
	75	03085-SU	Q75/CL/MC		1050	120	Clear	2,000	2.44"	12	
	100	03090-SU	Q100/CL/MC	ESN	1500	120	Clear	2,000	2.55"	12	
		03435-SU	Q100/CL/MC/CD1	ESN	1500	120	Clear	2,000	2.57"	12	
	150	03095-SU	Q150/CL/MC	ESL	2200	120	Clear	2,000	2.72"	12	
		03100-SU	Q150/FR/MC	ETH	2000	120	Frost	2,000	2.68"	12	
	250	03105-SU	Q250/CL/MC	EHT	3800	120	Clear	2,000	3.11"	12	
	500	03110-SU	Q500/CL/MC	EVR	8000	120	Clear	2,000	3.67"	12	



SINGLE ENDED | DOUBLE CONTACT

Base	Watts	Item	Description	ASNI	Lumens	Volts	Finish	Hours	MOL	Pkg.	Features
Double Contact Bayonet (BA15d)	35	03111-SU	Q35/CL/DC		280	120	Clear	2,000	1.82"	12	
	50	03115-SU	Q50/CL/DC		500	120	Clear	2,000	2.11"	12	
		03114-SU	Q50/FR/DC		490	120	Frost	2,000	2.16"	12	
	75	03120-SU	Q75/CL/DC		1050	120	Clear	2,000	2.12"	12	
	100	03125-SU	Q100/CL/DC	ESR	1500	120	Clear	2,000	2.00"	12	
	150	03130-SU	Q150/CL/DC	ETC	2200	120	Clear	2,000	2.32"	12	
		03135-SU	Q150/FR/DC	ETF	2100	120	Frost	2,000	2.45"	12	
	250	03140-SU	Q250/CL/DC	ESS	4000	120	Clear	2,000	2.51"	50	
500	03145-SU	Q500/CL/DC		8000	120	Clear	2,000	3.89"	50		
Inter-mediate (E14)	75	03149-SU	Q75/CL/E14		1050	120	Clear	2,000	2.64"	12	



SINGLE ENDED | JC

Base	Watts	Item	Description	ASNI	Lumens	Volts	Finish	Hours	MOL	Pkg.	Features
2-Pin (G4)	5	03245-SU	Q5/CL/G4/12V		25	12	Clear	2,000	1.20"	12	
	10	03250-SU	Q10/CL/G4/12V		100	12	Clear	2,000	1.23"	12	
		03253-SU	Q10/FR/G4/12V		90	12	Frost	2,000	1.15"	12	
		03255-SU	Q20/CL/G4/12V		220	12	Clear	2,000	1.22"	12	
	20	03425-SU	Q20/CL/GY4/12V/CD2		220	12	Clear	2,000	1.22"	6	
		03258-SU	Q20/FR/G4/12V		210	12	Frost	2,000	1.15"	12	
		03260-SU	Q20/CL/G4/24V		220	24	Clear	2,000	1.20"	12	



SINGLE ENDED (CONTINUED)

Base	Watts	Item	Description	ASNI	Lumens	Volts	Finish	Hours	MOL	Pkg.	Features
2-Pin Glass (GY6.35)	20	03263-SU	Q20/CL/GY6.35/12V		220	12	Clear	2,000	1.54"	12	
		03266-SU	Q20/CL/GY6.35/120V		120	120	Clear	2,000	1.70"	12	
		03265-SU	Q20/CL/GY6.35/120V		120	120	Clear	2,000	1.75"	12	
	35	03273-SU	Q35/CL/GY6.35/12V/CD2		525	12	Clear	2,000	1.54"	12	
		03270-SU	Q35/CL/GY6.35/12V		525	12	Clear	2,000	1.59"	12	
		03275-SU	Q35/CL/GY6.35/120V		315	120	Clear	2,000	1.75"	12	
	50	03280-SU	Q50/CL/GY6.35/12V		850	12	Clear	2,000	1.54"	12	
		03430-SU	Q50/CL/GY6.35/12V/CD2		900	12	Clear	2,000	1.54"	12	
		03299-SU	Q50/FR/GY6.35/12V		850	12	Frost	2,000	1.71"	12	
		03290-SU	Q50/CL/GY6.35/24V		600	24	Clear	2,000	1.50"	12	
		03285-SU	Q50/CL/GY6.35/120V/CD2		500	120	Clear	2,000	1.64"	6	
	75	03261-SU	Q50/CL/GY6.35/120V		500	120	Clear	2,000	1.97"	12	
		03295-SU	Q75/CL/GY6.35/12V		1350	12	Clear	2,000	1.77"	12	
	100	03297-SU	Q75/CL/GY6.35/120V		1050	120	Clear	2,000	1.75"	12	
		03300-SU	Q100/CL/GY6.35/12V		1900	12	Clear	2,000	1.77"	12	
150	03305-SU	Q100/CL/GY6.35/120V	JCD	1500	120	Clear	2,000	2.06"	12		
	03310-SU	Q150/CL/GY6.35/12V		2450	12	Clear	2,000	1.71"	12		
		03315-SU	Q150/CL/GY6.35/120V		2400	120	Clear	2,000	2.31"	12	



SINGLE ENDED | JCD

Base	Watts	Item	Description	ASNI	Lumens	Volts	Finish	Hours	MOL	Pkg.	Features
2-Pin All Glass (GY8)	20	21995-SU	Q20/CL/GY8/120V		120	120	Clear	2,000	1.70"	12	
		22000-SU	Q20/CL/GY8/120V			120	Clear	2,000	1.70"	12	
	35	22005-SU	Q35/CL/GY8/120V		300	120	Clear	2,000	1.72"	12	
	50	22010-SU	Q50/CL/GY8/120V		500	120	Clear	2,000	1.56"	12	
	100	22015-SU	Q100/CL/GY8/120V		1500	120	Clear	2,000	1.68"	12	



SINGLE ENDED | G9

Base	Watts	Item	Description	ASNI	Lumens	Volts	Finish	Hours	MOL	Pkg.	Features
Wire Style Base (G9)	25	66025-SU	Q25/CL/G9/120V		200	120	Clear	2,000	1.60"	12	
		66030-SU	Q25/FR/G9/120V		190	120	Frost	2,000	1.56"	12	
	40	66070-SU	Q40/CL/G9/120V		380	120	Clear	2,000	1.55"	12	
		66075-SU	Q40/FR/G9/120V		350	120	Frost	2,000	1.57"	12	
	50	66076-SU	Q50/CL/G9/120V		600	120	Clear	2,000	1.57"	12	
		66077-SU	Q50/G9/FR/120V		550	120	Frost	2,000	1.57"	12	
	60	66035-SU	Q60/CL/G9/120V		800	120	Clear	2,000	1.55"	12	
		66040-SU	Q60/FR/G9/120V		720	120	Frost	2,000	1.55"	12	



DOUBLE ENDED T3

Base	Watts	Item	Description	Length	ASNI	Lumens	Volts	Finish	Hours	MOL	Pkg.	Features	
RSC (R7s)	75	03320-SU	Q75T3/CL/S	78mm	J78	1000	120	Clear	2,000	3.08"	12		
		03325-SU	Q100T3/CL/S	78mm		1000	120	Clear	1,500	3.08"	12		
	100	03330-SU	Q100T3/CL	118mm		1000	120	Clear	1,500	4.66"	12		
		03328-SU	Q100T3/CL/S/CD1	78mm		1000	120	Clear	1,500	3.08"	12		
	150	03335-SU	Q150T3/CL/S	78mm	J78	1950	120	Clear	1,500	3.10"	12		
		03414-SU	Q150T3/CL/S/CD2	78mm		1950	120	Clear	1,500	3.06"	12		
		03411-SU	Q150T3/CL/S/CD1	78mm		1950	120	Clear	1,500	3.08"	12		
		03395-SU	Q150T3/CL/CD2	118mm		1950	120	Clear	1,500	4.67"	12		
		03340-SU	Q150T3/CL	118mm		1950	120	Clear	1,500	4.67"	10		
	200	03350-SU	Q200T3/CL	118mm		2700	120	Clear	1,500	4.60"	12		
		03345-SU	Q200T3/CL/S	78mm		2800	120	Clear	1,500	3.08"	12		
	250	03355-SU	Q250T3/CL/S	78mm		4000	120	Clear	1,500	3.08"	12		
	Re-cessed Single Contact (R7s)	300	03402-SU	Q300T3/CL/CD1	118mm	EHM	4200	120	Clear	1,500	4.67"	12	
			03365-SU	Q300T3/CL	118mm		4200	120	Clear	1,500	4.67"	12	
500		03408-SU	Q500T3/CL/CD1	118mm	FCL	9000	120	Clear	2,000	4.65"	12		
		03370-SU	Q500T3/CL	118mm	FCL	9000	120	Clear	1,500	4.70"	12		
		03405-SU	Q500T3/CL/CD2	118mm	FCL	9000	120	Clear	1,500	4.65"	6		
1000		03383-SU	Q1000T3/CL/120V	254mm		19000	120	Clear	1,500	10.02"	12		
		03375-SU	Q1000T3/CL/3/S	189mm		19000	130	Clear	1,500	7.44"	12	▲	
		03380-SU	Q1000T3/CL/240V	254mm		18000	240	Clear	1,500	9.99"	12	▲	
1500		03388-SU	Q1500T3/CL/208V			28000	208	Clear	1,500	10.02"	12	▲	
		03390-SU	Q1500T3/CL/240V	254mm		28000	240	Clear	1,500	9.99"	12	▲	



MR8 MINI REFLECTOR

Base	Watts	Item	Description	CBCP	Lumens	Volts	Finish	Beam Spread	Hours	MOL	Pkg.	Features
2-Pin (G4)	20	03194-SU	20MR8/CG/SP/12V		300	12	Cover	WF 10°	2,000	1.32"	12	
		03192-SU	20MR8/CG/G4/FL/12V	300		12	Cover	FL 36°	2,000	1.32"	12	
	35	03197-SU	35MR8/CG/G4/SP/12V	800		12	Cover	SP 10°	2,000	1.32"	12	
		03196-SU	35MR8/CG/G4/FL/12V	500		12	Cover	FL 36°	2,000	1.32"	12	



MR11 MINI REFLECTOR

Base	Watts	Item	Description	ASNI	CBCP	Lumens	Volts	Finish	Beam Spread	Hours	Mol	Pkg.	Features
2-Pin (GU4)	5	03445-SU	5MR11/CG/GU4/NFL/6V	JCR	300	30	6	Cover	NFL 30°	2,000	1.37"	24	▼
		03450-SU	5MR11/CG/GU4/NFL/12V	JCR	265	35	12	Cover	NFL 30°	2,000	1.33"	24	
	10	03455-SU	10MR11/CG/GU4/NFL/6V	JCR	630	90	6	Cover	NFL 30°	2,000	1.33"	24	▼
		03460-SU	10MR11/CG/GU4/NFL/12V	JCR	890	110	12	Cover	NFL 30°	2,000	1.30"	6	



MR11 MINI REFLECTOR (CONTINUED)

Base	Watts	Item	Description	ASNI	CBCP	Volts	Finish	Beam Spread	Hours	MOL	Pkg.	Features
Double Contact (BA15d)	20	03195-SU	20MR11/CG/DC/NSP/12V	FST	2500	12	Cover	NSP 10°	2,000	1.58"	24	
2-Pin (GU4)	20	03165-SU	20MR11/GU4/NSP/12V	FTB	2500	12	Open	NSP 10°	2,000	1.31"	24	
		03170-SU	20MR11/GU4/NFL/12V	FTC	2500	12	Open	NSP 20°	2,000	1.32"	24	
		03175-SU	20MR11/GU4/NFL/12V	FTD	640	12	Open	NFL 30°	2,000	1.33"	6	
		66155-SU	20MR11/CG/GU4/NFL/12V/BB	FTD	750	12	Black	NFL 30°	2,000	1.31"	24	■
		66150-SU	20MR11/CG/GU4/NFL/12V/SB	FTD	750	12	Cover	NFL 30°	2,000	1.31"	24	
35	03180-SU	35MR11/GU4/NSP/12V	FTE	6400	12	Open	NSP 10°	2,000	1.34"	30		
	03185-SU	35MR11/GU4/SP/12V	FTF	2200	12	Open	SP 16°	2,000	1.34"	24		
	03190-SU	35MR11/GU4/NFL/12V	FTH	600	12	Open	NFL 30°	2,000	1.34"	24		

MR11 COLORED



Base	Watts	Item	Description	ASNI	CBCP	Volts	Finish	Beam Spread	Hours	MOL	Pkg.	Features
2-Pin (GU4)	20	66130-SU	20MR11/GU4/SP/12V/B	FTB		12	Blue	SP 10°	2,000	1.31"	24	■
		66140-SU	20MR11/GU4/SP/12V/O	FTB		12	Orange	SP 10°	2,000	1.31"	24	■
		66145-SU	20MR11/GU4/SP/12V/R	FTB		12	Red	SP 10°	2,000	1.31"	24	■
		66160-SU	20MR11/GU4/SP/12V/Y	FTB		12	Yellow	SP 10°	2,000	1.31"	12	■

MR11 MINI REFLECTOR



Base	Watts	Item	Description	ASNI	CBCP	Volts	Finish	Beam Spread	Hours	MOL	Pkg.	Features
Double Contact (BA15d)	20	03198-SU	20MR11/CG/DC/NFL/12V	FSV	640	12	Cover	NFL 30°	2,000	1.58"	24	
	35	03193-SU	35MR11/DC/NSP/12V	GDX	4400	12	Open	NSP 10°	2,000	1.58"	24	
Twist & Lock (GU10)	20	66165-SU	20MR11/CG/GU10/FL/120V	FTD	700	120	Cover	FL 36°	2,000	1.99"	12	
	35	66065-SU	35MR11/CG/GU10/FL/120V	FTH	800	120	Cover	FL 36°	2,000	1.85"	12	

MR16 MINI REFLECTOR



Base	Watts	Item	Description	ASNI	CBCP	Lumens	Volts	Finish	Beam Spread	Hours	Mol	Pkg.
2-Pin (GU5.3)	20	03205-SU	20MR16/NSP/12V	ESX	3300	230	12	Open	NSP 12°	2,000	1.76"	24
		03203-SU	20MR16/CG/FL/12V	BAB	650	230	12	Cover	FL 38°	2,000	1.76"	24
		03200-SU	20MR16/FL/12V	BAB	600		12	Open	FL 38°	2,000	1.76"	6
	35	03213-SU	35MR16/FL/12V	FMW	1000	500	12	Open	FL 38°	2,000	1.76"	24
		03235-SU	35MR16/CG/FL/120V	FMW	500	280	120	Cover	FL 38°	2,000	1.87"	24

■ = Carded (# signifies pieces per card) ▲ = High Voltage ▼ = Low Voltage



MR16 MINI REFLECTOR (CONTINUED)

Base	Watts	Item	Description	ASNI	CBCP	Lumens	Volts	Finish	Beam Spread	Hours	MOL	Pkg.	Features
2-Pin (GU5.3)	50	03215-SU	50MR16/NSP/12V	EXT	8000	750	12	Open	NSP 12°	2,000	1.76"	24	
		03220-SU	50MR16/NFL/12V	EXZ	3000	750	12	Open	NFL 24°	2,000	1.76"	24	
		66085-SU	50MR16/NSP/12V/B	EXT			12	Blue	NSP 12°	2,000	1.77"	12	■
		66090-SU	50MR16/NSP/12V/G	EXT			12	Green	NSP 12°	2,000	1.77"	12	■
		66100-SU	50MR16/NSP/12V/R	EXT			12	Red	NSP 12°	2,000	1.77"	12	■
		66110-SU	50MR16/NSP/12V/Y	EXT			12	Yellow	NSP 12°	2,000	1.77"	24	■
		03243-SU	50MR16/CG/FL/12V	EXN	1500	800	12	Cover	FL 38°	2,000	1.76"	24	Cover Guard
		03415-SU	50MR16/FL/12V/CD1	EXN	1500		12	Open	FL 38°	2,000	1.76"	12	
		03210-SU	50MR16/FL/12V	EXN	1500	1500	12	Open	FL 38°	2,000	1.76"	12	
		03237-SU	50MR16/CG/FL/24V	EXN	1250	615	24	Cover	FL 38°	2,000	1.76"	24	Cover Guard
		03240-SU	50MR16/CG/FL/120V	EXN	750	420	120	Cover	FL 38°	2,000	1.90"	24	Cover Guard
		2-Pin All Glass (GY8)	75	03225-SU	75MR16/NSP/12V	EYF	1150		12	Open	NSP 12°	2,000	1.76"
75	03230-SU		75MR16/FL/12V	EYC	1150	1200	12	Open	FL 38°	2,000	1.76"	24	
2-Pin All Glass (GY8)	20	66015-SU	20MR16/CG/GY8/FL/120V	BAB	300	120	120	Cover	FL 38°	2,000	1.77"	24	Cover Guard
	50	66125-SU	50MR16/CG/GY8/FL/120V	EXN		470	120		FL 38°	2,000	1.77"	12	

MR16 MINI REFLECTOR



Base	Watts	Item	Description	ASNI	CBCP	Lumens	Volts	Finish	Beam Spread	Hours	MOL	Pkg.	Features
2-Pin (GU5.3)	20	66005-SU	20MR16/CG/FL/12V/SB	BAB	650		12	Cover	FL 38°	2,000	1.75"	12	■
	35	66170-SU	35MR16/CG/FL/12V/BB	FMW	1000	425	12	Cover	FL 38°	2,000	1.75"	12	■
		66060-SU	35MR16/CG/FL/12V/SB	FMW	1000	425	12	Cover	FL 38°	2,000	1.77"	12	■
	50	66020-SU	50MR16/CG/NFL/12V/BB	EXZ	3500	370	12	Cover	NFL 24°	2,000	1.75"	12	■
		66045-SU	50MR16/CG/NFL/12V/SB	EXZ	3500		12	Cover	NFL 24°	2,000	1.75"	12	■
		66080-SU	50MR16/CG/FL/12V/BB	EXN	1500	600	12	Cover	FL 38°	2,000	1.77"	12	■
	66105-SU	50MR16/CG/FL/12V/SB	EXN	1500	650	12	Cover	FL 38°	2,000	1.77"	12	■	

MR16 MINI REFLECTOR



Base	Watts	Item	Description	ASNI	CBCP	Lumens	Volts	Finish	Beam Spread	Hours	MOL	Pkg.	Features
Twist & Lock (GU10)	20	66010-SU	20MR16/GU10/FL/120V	BAB	150	88	120	Cover	FL 38°	2,000	2.09"	24	
		03232-SU	35MR16/CG/GU10/FL/120V	FMW	450	240	120	Cover	FL 38°	2,000	2.09"	6	
	35	66055-SU	35MR16/CG/GU10/ FL/120V/BB	FMW	450		120	Cover	FL 38°	2,000	2.07"	12	■
		66175-SU	35MR16/CG/GU10/ FL/120V/SB	FMW	450		120	Cover	FL 38°	2,000	2.08"	24	■
	50	66050-SU	50MR16/GU10/NFL/120V	EXZ	900	370	120	Cover	NFL 24°	2,000	2.09"	24	
		03233-SU	50MR16/CG/GU10/FL/120V	EXN	800	370	120	Cover	FL 38°	2,000	2.09"	24	



MR16 MINI REFLECTOR

Base	Watts	Item	Description	ASNI	CBCP	Lumens	Volts	Finish	Beam Spread	Hours	MOL	Pkg.	Features
Twist & Lock (GU10)	50	66115-SU	50MR16/CG/GU10/FL/120V/BB	EXN	800	370	120	Cover	FL 38°	2,000	2.10"	12	■
		66120-SU	50MR16/CG/GU10/FL/120V/SB	EXN	800	370	120	Cover	FL 38°	2,000	2.08"	12	■



MR16 JDR MINI REFLECTOR

Base	Watts	Item	Description	ASNI	CBCP	Lumens	Volts	Finish	Beam Spread	Hours	MOL	Pkg.	Features
Inter-mediate (E17)	75	03000-SU	75JDR/N/E17/FL/120V	JDR	1200	830	120	Open	FL 38°	2,000	2.95"	12	
Medium (E26)	75	03005-SU	75JDR/MED/FL/120V	JDR	1200	830	120	Open	FL 38°	2,000	2.69"	12	
	100	03015-SU	100JDR/MED/FL/120V	JDR	1500		120	Open	FL 38°	2,000	2.74"	12	



MR16 JDR MINI REFLECTOR

Base	Watts	Item	Description	ASNI	CBCP	Lumens	Volts	Finish	Beam Spread	Hours	MOL	Pkg.	Features
Medium (E26)	50	03470-SU	50MR16/MED/FL/120V	EXN	500	440	120	Cover	FL 38°	2,000	2.13"	25	



PAR16 REFLECTOR

Base	Watts	Item	Description	ASNI	CBCP	Lumens	Volts	Finish	Beam Spread	Hours	MOL	Pkg.	Features
Medium (E26)	45	24100-SU	45PAR16/HAL/NFL		480		120		NFL 30°	2,000	3.09"	15	
	60	24000-SU	60PAR16/HAL/NFL		650	420	120		NFL 30°	2,000	3.09"	15	
	75	24050-SU	75PAR16/HAL/NFL		1400		120		NFL 30°	2,000	3.07"	15	



PAR20 REFLECTOR

Base	Watts	Item	Description	ASNI	CBCP	Lumens	Volts	Finish	Beam Spread	Hours	MOL	Pkg.	Features
Medium (E26)	39	26000-SU	39PAR20/HAL/SP		2400	520	120		SP 12°	1,500	3.10"	15	
		26005-SU	39PAR20/HAL/NFL		1100	520	120		NFL 25°	1,500	3.10"	15	
50	50	25050-SU	50PAR20/HAL/NFL/B				120	Blue	NFL 30°	2,000	3.10"	15	■
		25055-SU	50PAR20/HAL/NFL/G				120	Green	NFL 30°	2,000	3.10"	15	■
		25065-SU	50PAR20/HAL/NFL/Y				120	Yellow	NFL 30°	2,000	3.15"	15	■



PAR30 REFLECTOR

Base	Watts	Item	Description	CBCP	Lumens	Volts	Finish	Beam Spread	Hours	MOL	Pkg.	Features
Medium (E26)	38	26010-SU	39PAR30/HAL/SP	2400	520	120		SP 10°	1,500	3.48"	15	
	39	26020-SU	39PAR30/HAL/FL	900	520	120		FL	1,500	3.52"	15	
	60	26025-SU	60PAR30/HAL/SP	12000	1080	120		SP 10°	1,000	3.49"	15	
	50	25125-SU	50PAR30/HAL/NSP		550	120	Clear	NSP 9°	2,000	3.50"	15	
	60	26035-SU	60PAR30/HAL/FL	1250	1080	120		FL 35°	1,000	3.48"	15	
	75	25155-SU	75PAR30/HAL/NFL/B			120	Blue	NFL 30°	2,000	3.49"	15	■
		25170-SU	75PAR30/HAL/NFL/Y			120	Yellow	NFL 30°	2,000	3.57"	15	■



PAR30 LONG NECK REFLECTOR

Base	Watts	Item	Description	CBCP	Lumens	Volts	Finish	Beam Spread	Hours	MOL	Pkg.	Features
Medium (E26)	38	26045-SU	39PAR30/LN/HAL/NFL	1100	520	120		NFL 25°	1,500	4.65"	15	
	60	26055-SU	60PAR30/LN/HAL/SP	12000	1080	120		SP 10°	1,080	4.62"	15	
		26065-SU	60PAR30/LN/HAL/FL	1250	1080	120		FL 35°	1,080	4.60"	15	



PAR38 REFLECTOR

Base	Watts	Item	Description	CBCP	Lumens	Volts	Finish	Beam Spread	Hours	MOL	Pkg.	Features
Medium (E26)	39	26070-SU	39PAR38/HAL/NFL	1100	520	120		NFL 25°	1,500	5.14"	15	
	60	26080-SU	60PAR38/HAL/FL	1250	1080	120		FL 35°	1,000	5.13"	15	
		26085-SU	70PAR38/HAL/SP	15000	1310	120		SP	1,000	5.20"	15	
	70	26087-SU	70PAR38/HAL/FL	1500	1310	120		FL 35°	1,000	5.14"	15	
		80	26097-SU	80PAR38/HAL/NFL	3500	1590	120		FL 38°	1,000	5.16"	15



R20 REFLECTOR

Base	Watts	Item	Description	CBCP	Lumens	Volts	Finish	Beam Spread	Hours	MOL	Pkg.	Features
Medium (E26)	45	25262-SU	45R20/HAL/ECO/FL		550	120		FL	1,500	3.85"	12	



AR ALUMINUM REFLECTOR 12 VOLT

Base	Watts	Item	Description	CBCP	Lumens	Volts	Finish	Beam Spread	Hours	MOL	Pkg.	Features
Double Contact Bayonet (BA15d)	20	21505-SU	20AR70/FL/12V	1650		12		FL 24°	2,000	1.97"	12	
		21500-SU	20AR70/SP/12V	1400		12		SP 8°	2,000	2.00"	12	
	50	21515-SU	50AR70/FL/12V	3800		12		FL 24°	2,000	2.13"	12	

AR ALUMINUM REFLECTOR 12 VOLT



Base	Watts	Item	Description	CBCP	Lumens	Volts	Finish	Beam Spread	Hours	MOL	Pkg.	Features
Screw Terminal (G53)	35	21525-SU	35AR111/FL/12V	1700		12		FL 24°	2,000	2.25"	12	
		21520-SU	35AR111/SP/12V	13500		12		SP 8°	2,000	2.15"	12	
	50	21535-SU	50AR111/FL/12V	3800	650	12		FL 24°	2,000	2.25"	6	
		21530-SU	50AR111/SP/12V	17000		12		SP 8°	2,000	2.15"	6	
	75	21545-SU	75AR111/FL/12V	6000		12		FL 24°	2,000	2.25"	12	
		21550-SU	75AR111/WFL/12V	1650		12		FL 45°	2,000	2.16"	6	
		21540-SU	75AR111/SP/12V	30000		12		SP 8°	2,000	2.15"	12	

A TYPE

Base	Watts	Item	Description	CBCP	Lumens	Volts	Finish	Beam Spread	Hours	MOL	Pkg.	Features
Medium (E26)	28	25140-SU	28A/HAL/SW		400	120	Frost		1,500	4.20"	12	
	42	25136-SU	42A/HAL/CL		750	120	Clear		1,500	4.20"	12	
		25137-SU	53A/HAL/CL		1050	120	Clear		1,500	4.20"	12	
	53	25142-SU	53A/HAL/SW		1000	120	White		1,500	4.20"	12	
		72	25138-SU	72A/HAL/CL		1490	120	Clear		1,500	4.20"	12
			25143-SU	72A/HAL/SW		1490	120	Frost		1,500	4.20"	12

sunlite

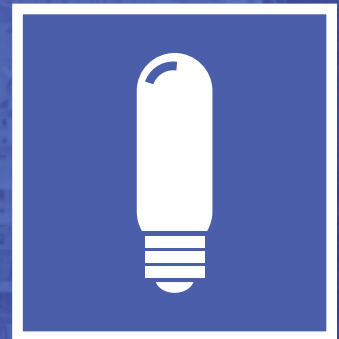

High Intensity Discharge

HIGH PRESSURE SODIUM

BASE	Watts	Item	Description	ANSI	Finish	Lumens	Hours	MOL	Pkg.
Medium (E26)	35	03600-SU	LU35/MED	S76	Clear	2250	16,000	5.36"	12
	50	03605-SU	LU50/MED	S68	Clear	3600	24,000	5.36"	12
	70	03610-SU	LU70/MED	S62	Clear	6000	24,000	5.30"	12
	100	03615-SU	LU100/MED	S54	Clear	8500	20,000	5.52"	12
	150	03620-SU	LU150/MED	S55	Clear	15000	20,000	5.62"	12



HIGH PRESSURE SODIUM

BASE	Watts	Item	Description	ANSI	Finish	Lumens	Hours	MOL	Pkg.
Mogul (E39)	70	03625-SU	LU70/MOG	S62	Clear	6300	24,000	6.90"	12
	100	03630-SU	LU100/MOG	S54	Clear	8500	20,000	7.49"	12
	150	03635-SU	LU150/MOG	S55	Clear	16000	20,000	7.42"	12
	250	03634-SU	LU250/MOG	S50	Clear	28000	24,000	9.50"	12



HIGH PRESSURE SODIUM

BASE	Watts	Item	Description	ANSI	Finish	Lumens	Hours	MOL	Pkg.
Mogul (E39)	400	03636-SU	LU400/MOG	S51	Clear	48000	20,000	9.40"	12



HIGH PRESSURE SODIUM

BASE	Watts	Item	Description	ANSI	Finish	Lumens	Hours	MOL	Pkg.
Mogul (E39)	1000	03633-SU	LU1000	S52	Clear	125000	24,000	14.50"	6



METAL HALIDE

BASE	Watts	Item	Description	ANSI	Finish	Lumens	Hours	MOL	Pkg.
Medium (E26)	50	03637-SU	MH50/U/MED	M110	Clear	3400	10,000	5.26"	12
	70	03640-SU	MH70/U/MED	M98	Clear	5600	15,000	5.30"	12
		03645-SU	MH100/U/MED	M90	Clear	9000	12,000	5.36"	12
	100	03648-SU	MH100/C/U/MED	M90	Coated	7700	15,000	5.44"	12
		03650-SU	MH150/U/MED	M102	Clear	14000	15,000	5.30"	12
	150	03623-SU	MH150/C/U/MED	M102	Coated	11500	10,000	5.32"	12
		03655-SU	MH175/U/MED	M57	Clear	14000	10,000	5.40"	12
	175	03668-SU	MH175/C/U/MED	M57	Coated	13000	10,000	5.38"	12





METAL HALIDE

BASE	Watts	Item	Description	ANSI	Finish	Lumens	Hours	MOL	Pkg.
Mogul (E39)	175	03656-SU	MH175/U/MOG	M57	Clear	14000	10,000	8.09"	12
	250	03658-SU	MH250/U/MOG	M58	Clear	21000	15,000	8.24"	12
	400	03663-SU	MH400/U/MOG	M59	Clear	36000	12,000	10.96"	6

METAL HALIDE

BASE	Watts	Item	Description	ANSI	Finish	Lumens	Hours	MOL	Pkg.
Mogul (E39)	250	03693-SU	MH250/T15/MOG	M58	Clear	21000	10,000	9.76"	12
	400	03695-SU	MH400/T15/MOG	M59	Clear	36000	10,000	11.01"	12

PROTECTED METAL HALIDE

BASE	Watts	Item	Description	ANSI	Finish	Lumens	Hours	MOL	Pkg.
Medium (E26)	50	03638-SU	MP50/U/MED	M110/O	Clear	3200	10,000	5.29"	12
		03639-SU	MP50/C/U/MED	M110/O	Coated	3200	10,000	5.40"	12
	70	03641-SU	MP70/U/MED	M98/O	Clear	5600	15,000	5.30"	12
		03642-SU	MP70/C/U/MED	M98/O	Coated	5000	15,000	5.40"	12
	100	03646-SU	MP100/U/MED	M90/O	Clear	8500	15,000	5.26"	12
		03647-SU	MP100/C/U/MED	M90/O	Coated	8100	15,000	5.41"	12
150	03651-SU	MP150/U/MED	M102/O	Clear	13300	15,000	5.30"	12	
	03653-SU	MP150/C/U/MED	M102/O	Coated	12600	15,000	5.41"	12	
Mogul (E39)	175	03654-SU	MP175/U/MOG/PS	M152/O	Clear	16500	15,000	8.03"	12
	250	03659-SU	MP250/U/MOG/PS	M153/O	Clear	23800	15,000	8.37"	12
Mogul (EX39)	400	03664-SU	MP400/U/MOG/PS	M155/O	Clear	33000	15,000	11.00"	6

METAL HALIDE

BASE	Watts	Item	Description	ANSI	Finish	Lumens	Hours	MOL	Pkg.
Mogul (E39)	1000	03680-SU	MH1000/U/BT37	M47	Clear	110000	12,000	11.00"	6
		03681-SU	MH1000/U/BT56	M47/S	Clear	110000	12,000	15.30"	6

MERCURY VAPOR

BASE	Watts	Item	Description	ANSI	Finish	Lumens	Hours	MOL	Pkg.
Medium (E26)	100	03675-SU	MV100/DX/MED	H38	Coated	4000	6,000	5.38"	12
Mogul (E39)	100	03670-SU	MV100/DX/MOG	H38	Coated	4200	8,000	7.38"	12
	175	03665-SU	MV175/DX/MOG	H39	Coated	7500	10,000	8.20"	12
	250	03660-SU	MV250/DX/MOG	H37	Coated	12500	10,000	8.18"	12
	400	03679-SU	MV400/DX/MOG	H33	Coated	22000	12,000	11.04"	6

sunlite

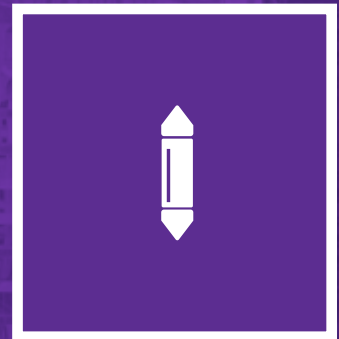

SPECIALTY



XELOGEN FESTOON

Base	Watts	Item	Description	Lumens	Volts	Hours	Color	MOL	Pkg.
Festoon	3	36000-SU	XEL/3W/12V/FT/C	25	12	20,000	Clear	1.7	10
		36010-SU	XEL/3W/24V/FT/C	30	24	10,000	Clear	1.7	10
		36015-SU	XEL/3W/24V/FT/F	30	24	10,000	Frost	1.7	10
		36005-SU	XEL/3W/12V/FT/F	25	12	20,000	Frost	1.67	10
	5	36020-SU	XEL/5W/12V/FT/C	50	12	20,000	Clear	1.7	10
		36030-SU	XEL/5W/24V/FT/C	50	24	15,000	Clear	1.7	10
		36025-SU	XEL/5W/12V/FT/F	50	12	20,000	Frost	1.67	10
		36035-SU	XEL/5W/24V/FT/F	50	24	15,000	Frost	1.7	10
	10	36040-SU	XEL/10W/12V/FT/C	120	12	20,000	Clear	1.67	10
		36050-SU	XEL/10W/24V/FT/C	120	24	10,000	Clear	1.7	10
		36045-SU	XEL/10W/12V/FT/F	120	12	20,000	Frost	1.7	10
		36055-SU	XEL/10W/24V/FT/F	120	24	10,000	Frost	1.7	10



XENON RIDIG LOOP

Base	Watts	Item	Description	Lumens	Volts	Hours	Color	MOL	Pkg.
Rigid Loop	3	35024-SU	XEN/3W/24V/RL/F	25	24	10,000	Frost	1.75"	10
		35000-SU	XEN/5W/12V/RL/C	45	12	10,000	Clear	1.75"	10
	5	35015-SU	XEN/5W/24V/RL/C	50	24	10,000	Clear	1.75"	10
		35025-SU	XEN/5W/24V/RL/F	50	24	10,000	Frost	1.75"	10
	10	35005-SU	XEN/10W/12V/RL/C	90	12	10,000	Clear	1.75"	10
		35020-SU	XEN/10W/24V/RL/C	90	24	10,000	Clear	1.75"	10
		35030-SU	XEN/10W/24V/RL/F	90	24	10,000	Frost	1.75"	10



XENON WEDGE

Base	Watts	Item	Description	Lumens	Volts	Hours	Color	MOL	Pkg.
Wedge	3	35050-SU	XEL/3W/12V/WG/C	30	12	20000	Clear	1"	10
		35055-SU	XEL/5W/12V/WG/C	3	12	10,000	Clear	1"	10
	5	35065-SU	XEL/5W/12V/WG/F	50	12	10,000	Frost	1"	10
		35075-SU	XEL/5W/24V/WG/C	50	24	10,000	Clear	1"	10
		35080-SU	XEL/5W/24V/WG/F	50	24	10,000	Frost	1"	10
	6	35100-SU	XEL/6W/28V/WG/C		28	15,000	Clear	1"	10
	7.2	35085-SU	XEL/7.2W/24V/WG/C		24	3000	Clear	1"	10
	10	35060-SU	XEL/10W/12V/WG/C	90	12	10,000	Clear	1"	10
		35090-SU	XEL/10W/24V/WG/C		24	10,000	Clear	1"	10

MINIS

Item	ASNI	Bulb	Volts	Base
72001-SU	42		3.2	
07070-SU	73	T1.75	14	W2x4.6d
07080-SU	85	T1.75	28	W2.1x4.9d
07120-SU	147	T3.25	7	W2.1x9.5d
07138-SU	161	T3.25	14	W2.1x9.5d
07140-SU	168	T3.25	14	W2.1x9.5d
07145-SU	192	T3.25	13	W2.1x9.5d
07150-SU	193	T3.25	14	W2.1x9.5d
07155-SU	194	T3.25	14	W2.1x9.5d
72006-SU	239		6.3	
72011-SU	269		32	
72017-SU	336		14	
07202-SU	400	T3.25	28	W2.1x9.5d
07220-SU	464	T3.25	28	W2.1x9.5d
07240-SU	585	T3.25	28	W2.1x9.5d
07250-SU	656	T3.25	28	W2.1x9.5d
07255-SU	657	T3.25	28	W2.1x9.5d
07280-SU	904	T5	13.5	W2.1x9.5d
07285-SU	906	T5	13	W2.1x9.5d
07290-SU	908	T5	6	W2.1x9.5d
07295-SU	909	T5	6	W2.1x9.5d
07388-SU	912	T5	12.8	W2.1x9.5d
07300-SU	912	T5	12	W2.1x9.5d
07305-SU	914	T5	4	W2.1x9.5d
07310-SU	915	T5	12	W2.1x9.5d
07320-SU	917	T5	12	W2.1x9.5d
07325-SU	918	T5	12.8	W2.1x9.5d
07330-SU	921	T5	12.8	W2.1x9.5d
07335-SU	922	T5	12.8	W2.1x9.5d
07338-SU	927	T5	6	W2.1x9.5d
07340-SU	939	T5	5.5	W2.1x9.5d
07365-SU	1141	S8	12.8	BA15s
07375-SU	1156	S8	12.8	BA15s
07380-SU	1157		12.8	
72032-SU	1209		6.1	
72034-SU	1432		3.2	
72035-SU	1488		14	
72036-SU	1680		6	
72037-SU	1738		2.7	
72038-SU	1767		2.5	
07381-SU	1815	T-3 1/4	14	
07518-SU	3156	S8	12.8	W2.5x16d
07520-SU	3157	S8	12.8	W2.5x16q

PHONE / 718.768.7000

FAX / 718.768.0970

WWW.SUNLITE.COM

STAGE & STUDIO

Item	ASNI	Bulb	Volts	Base
70000-SU	BRL/BCD	T3	12	G6.35
70101-SU	BLC	S11	120	
70103-SU	BMV	S11	120	
70005-SU	BTL	T6	120	P28s
70300-SU	BTN	T7	120	P28s
70007-SU	BTP	T7	120	P28s
70305-SU	BTR	T7	120	P28s
70008-SU	BVE	T6	120	GX9.5
71000-SU	BXE	T7	10	BA15s
71004-SU	CMV	T8 1/2	120	
70003-SU	CYC		120	
70022-SU	DAH	T12	120	
70010-SU	DDL	MR16	20	GX5.3
70016-SU	DDM	MR16	90	GX5.3
70280-SU	DDS		21	
70015-SU	DED	MR16	13.8	GX5.3
DGH-SU	DGH		120	
70021-SU	DJT	MR16	13.8	
70020-SU	DNE	TB16	120	GX7.9
70025-SU	DNF	MR16	21	GX7.9
70325-SU	DNS		120	
70030-SU	DRA	T4	120	G6.35
70036-SU	DWY/FAB	T4	120	R7s
70038-SU	DXN	T5	120	R7s
70035-SU	DYG	G7	30	GZ9.5
70043-SU	DYH	G7	120	GU5.3
70040-SU	DYs	G7	120	GZ9.5
70045-SU	DZE	T4	24	GZ9.5
70050-SU	EFM	MR16	8	GZ6.35
70055-SU	EFN	MR16	12	GZ6.35
70060-SU	EFP	MR16	12	GZ6.35
70065-SU	EFR	MR16	15	GZ6.35
70071-SU	EGE	T5	120	P28s
70072-SU	EGF	T6	120	P28s
70073-SU	EGG	T6	120	P28s
70070-SU	EGT	T7	120	G22
70075-SU	EHA	T6	120	GZ9.5
70076-SU	EHC/EHB	T4	120	G9.5
70080-SU	EHD	T4	120	G9.5
70082-SU	EHF	T6	120	G9.5
70083-SU	EHG	T5	120	G9.5
70085-SU	EHJ	T4	24	G6.35
70086-SU	EHV	T4	120	
70090-SU	EJA	MR16	21	GX5.3
70092-SU	EJG	T3	120	R7s
70095-SU	EJL	MR16	24	GX5.3
70100-SU	EJM	MR16	21	GX5.3
70105-SU	EJV	MR16	21	GX5.3

STAGE & STUDIO

Item	ASNI	Bulb	Volts	Base
70110-SU	EKE	MR16	21	GX5.3
70115-SU	ELB	MR16	30	GX5.3
70125-SU	ELC	MR16	24	GX5.3
70120-SU	ELC/5H	MR16	24	GX5.3
70121-SU	ELD/EJN	MR16	21	GX5.3
70130-SU	ELH	MR16	120	GY5.3
70290-SU	ENG	MR16	120	GY5.3
70135-SU	ENH	MR16	120	GY5.3
70140-SU	ENL	MR16	12	GX5.3
70141-SU	ENW	MR16	19	GX5.3
70145-SU	ENX	MR16	82	GY5.3
70150-SU	ENZ	MR16	30	GX5.3
70151-SU	EPN	MR16	12	
70155-SU	EsB/FHE	T3T3	6	G4
70160-SU	EsD	MR16	120	GY5.3
70161-SU	EsJ	MR16	82	GY5.3
71013-SU	EsN	T4	120	E11
70163-SU	ESP	T4	120	
70162-SU	EsY	T4	120	G6.35
70165-SU	ETJ	MR16	120	GY5.3
70170-SU	EVC	T5	24	G6.35
70265-SU	EVD	T6	36	GY6.35
70175-SU	EVW	MR16	82	GY5.3
70180-SU	EXR	MR13	82	GX5.3
70185-SU	EXY	MR13	82	GX5.3
70190-SU	EYB	T3.5	82	G5.3
70194-SU	EYH	G7	120	G5.3
70198-SU	EYs	MR16	12	GU5.3
70195-SU	EZR/JCR	MR16	120	GY5.3
70200-SU	FAD	T4	110	R7s
70202-SU	FCB	T4	120	R7s
70203-SU	FCL	T3	120	
70205-SU	FCM	T3	120	R7s
70210-SU	FCs	T4	24	G6.35
70213-SU	FCV		120	
70211-SU	FDB	T4	120	
70212-SU	FDN		120	
70215-SU	FDT	T3.5	12	GZ9.5
70220-SU	FEL	T6	24	G9.5
70225-SU	FHM	T3	120	R7s
70230-SU	FHs	MR13	82	GX5.3
70233-SU	FKW	T6	120	GY9.5
70234-SU	FLK			
70320-SU	FTK		120	
70235-SU	FXL	MR16	82	GY5.3
70236-SU	GCA	T3.5	120	GU5.3
70240-SU	H3-55	T3.5	12	PK22s
70245-SU	H3-70	T3.6	24	PK22s
71016-SU	JCR-M	MR11	12	G5.3-4.8

PHONE / 718.768.7000

FAX / 718.768.0970

WWW.SUNLITE.COM

4 EASY WAYS TO ORDER



Sign up at sunlite.com to access great features!

- ✓ Place & manage orders
- ✓ See pricing & availability
- ✓ See & print document history
- ✓ See new item arrivals
- ✓ New category pages
- ✓ Improved product search
- ✓ Print Spec sheets
- ✓ Mobile friendly



E-MAIL

Email us with any question at:
info@sunlite.com



ORDER ONLINE

Ordering is easy with our
New Portal
<https://www.sunlite.com/requestaccess>



PHONE

800.605.BULB (2852) or
718.768.7000 (out of NYC)



FAX

Fax in your order form to:
718.768.0970



CONNECT

[facebook.com/sunlite](https://www.facebook.com/sunlite)
twitter.com/sunlitebulbs
twitter.com/sunlite
[pinterest.com/sunlitebulbs](https://www.pinterest.com/sunlitebulbs)



HOURS

Eastern Standard Time

Sunday
Monday
Tuesday
Wednesday
Thursday
Friday
Saturday

CLOSED
8:00AM - 6:30PM
8:00AM - 6:30PM
8:00AM - 6:30PM
8:00AM - 6:30PM
8:00AM - 4:00PM
CLOSED

Sunshine Lighting
744 Clinton Street
Brooklyn, NY 11231



Lighting America one bulb at a time

